

LARISA-RS-CLIP16

~19° real spot beam. Clip fastening for 1.6 mm thick PCB

TECHNICAL SPECIFICATIONS:

Dimensions	9.9 x 9.9 mm
Height	7.5 mm
Fastening	clips
Colour	black
Box size	
Box weight	5.8 kg
Quantity in Box	10000 pcs
ROHS compliant	yes ⓘ



MATERIAL SPECIFICATIONS:

Component	Type	Material	Colour
LARISA-RS	Lens	PMMA	clear
LARISA-HOLDER-CLIP16	Holder	PC	black

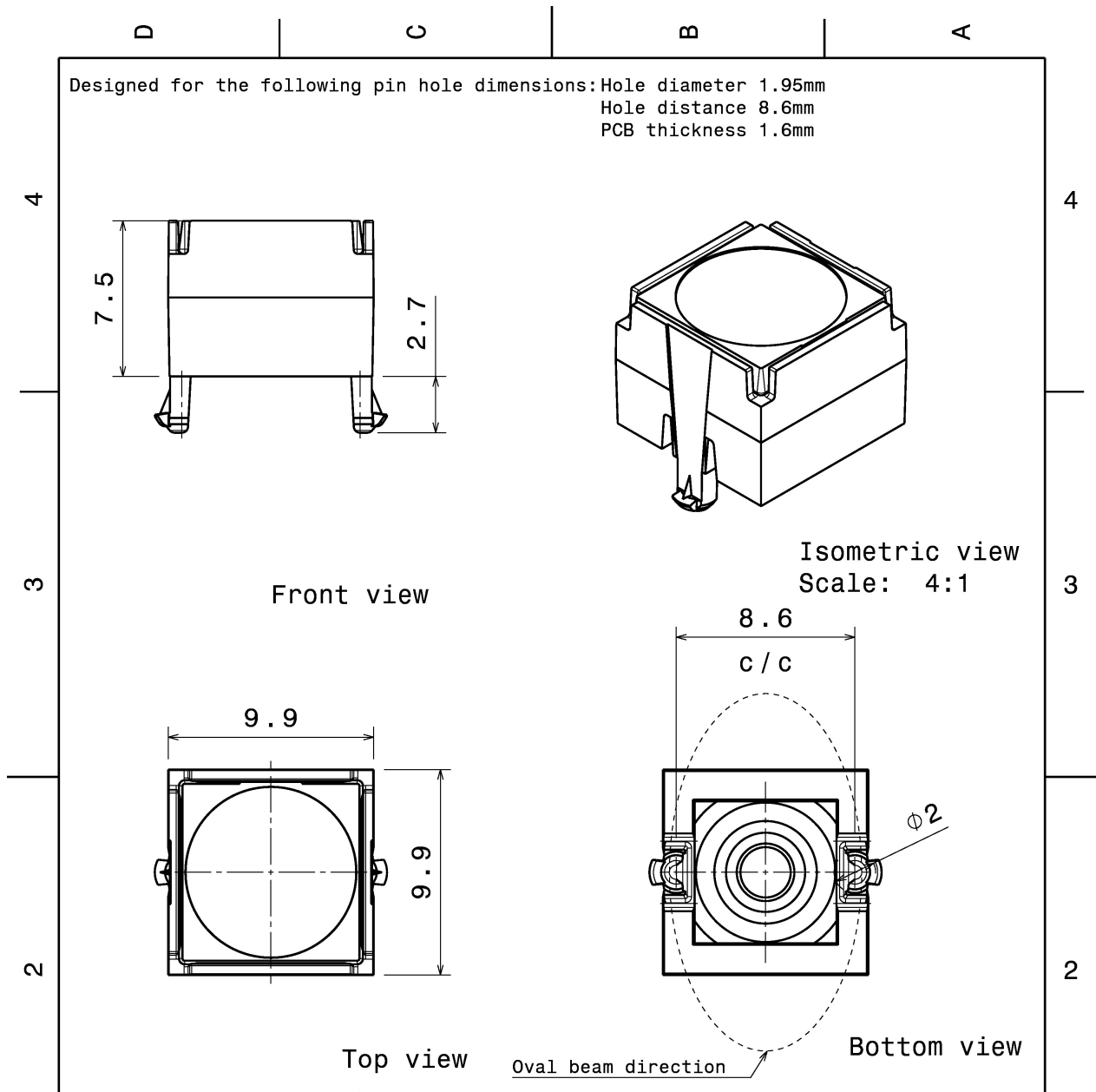

INDEX	PART NO	DESCRIPTION	MATERIAL	COLOUR
1	-	LARISA lens	PMMA	
2	C12908	LARISA-HOLDER-CLIP16	PC	black

Tolerances if not otherwise shown
According to DIN ISO 2768-1
Linear measures:
Up to 30mm class M, otherwise class C.
According to DIN ISO 2768-2
Form and position: class L

LEDiL

Ledil Oy
Salorankatu 10
FIN 24240 SALO
Finland

THIRD ANGLE PROJECTION:

DRAWING TITLE

LARISA-CLIP16 series

This drawing is the property of LEDiL Oy. It may not be reproduced, copied or communicated without a written agreement with LEDiL Oy.

SIZE PART NUMBER

A4

0,6 g

SHEET 1/1

D

A

PHOTOMETRIC DATA (MEASURED):



LED XQ-E
 FWHM 16.0°
 Efficiency 86 %
 Peak intensity 6.900 cd/lm
 Required components:

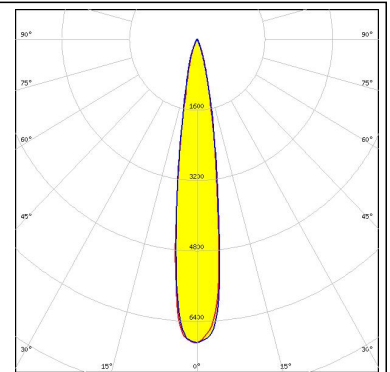

LED XQ-E HI
 FWHM 11.0°
 Efficiency 80 %
 Peak intensity 10.700 cd/lm
 Required components:

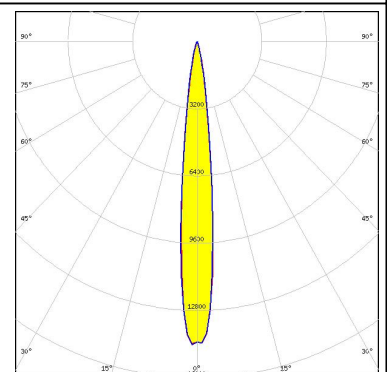



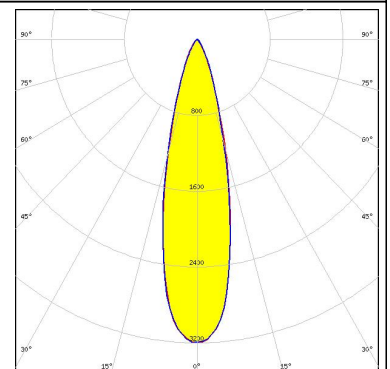
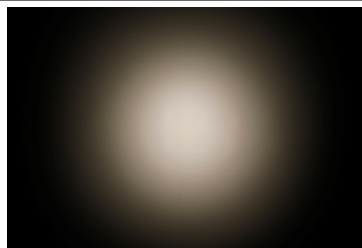

LED LUXEON A
 FWHM 26.0°
 Efficiency 89 %
 Peak intensity 3.200 cd/lm
 Required components:

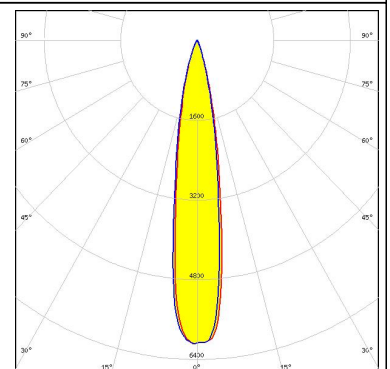



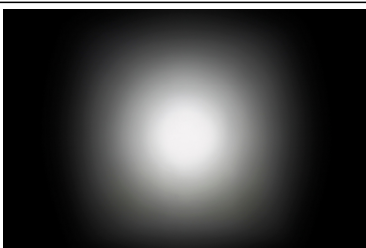
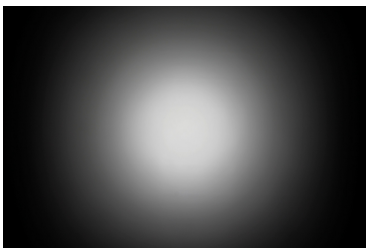
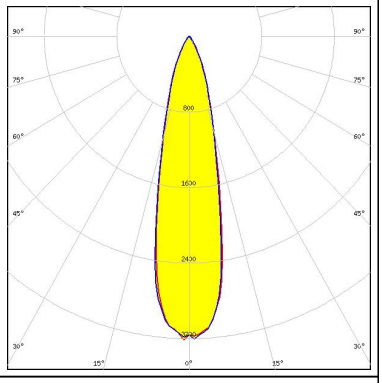

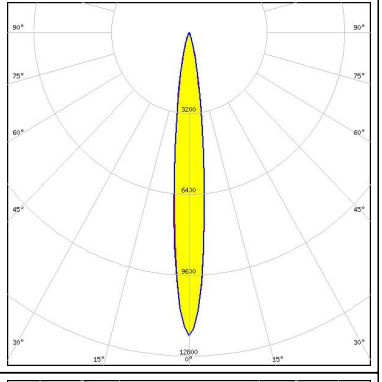
LED LUXEON C
 FWHM 17.0°
 Efficiency 86 %
 Peak intensity 6.100 cd/lm
 Required components:

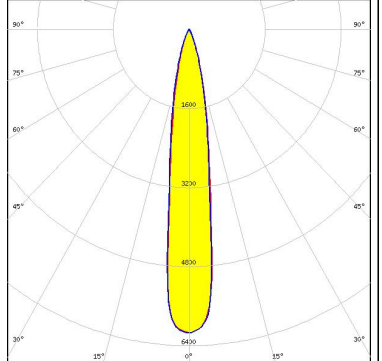

PHOTOMETRIC DATA (MEASURED):

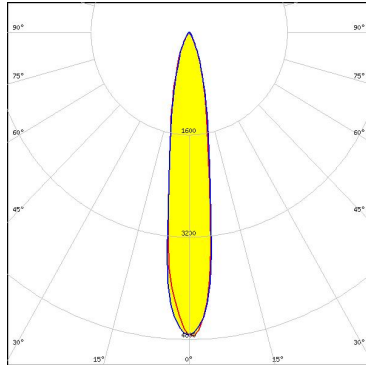
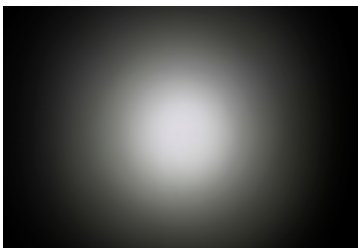
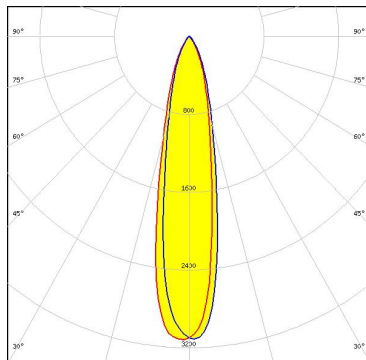
<p>LUMILEDS</p> <p>LED LUXEON Rebel</p> <p>FWHM 20.0°</p> <p>Efficiency 90 %</p> <p>Peak intensity 4.620 cd/lm</p> <p>Required components:</p>		
<p>LUMILEDS</p> <p>LED LUXEON Rebel ES</p> <p>FWHM 24.0°</p> <p>Efficiency 88 %</p> <p>Peak intensity 3.220 cd/lm</p> <p>Required components:</p>		
<p>LUMILEDS</p> <p>LED LUXEON Z</p> <p>FWHM 11.0°</p> <p>Efficiency 85 %</p> <p>Peak intensity 12.140 cd/lm</p> <p>Required components:</p>		
<p>LUMILEDS</p> <p>LED LUXEON Z ES</p> <p>FWHM 16.0°</p> <p>Efficiency 89 %</p> <p>Peak intensity 6.100 cd/lm</p> <p>Required components:</p>		

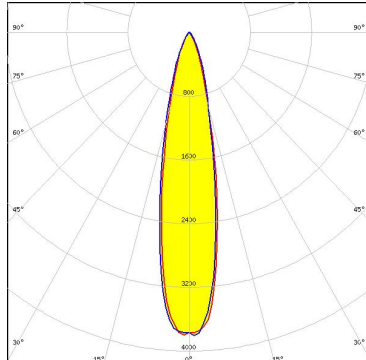
PHOTOMETRIC DATA (MEASURED):

<p>NICHIA</p> <p>LED NCSxx19A FWHM 16.0° Efficiency 84 % Peak intensity 4.750 cd/lm Required components:</p>		
<p>NICHIA</p> <p>LED NVSxx19A FWHM 21.0° Efficiency 81 % Peak intensity 3.140 cd/lm Required components:</p>		
<p>OSRAM <small>Opto Semiconductors</small></p> <p>LED Oslon Square EC FWHM 22.0° Efficiency 86 % Peak intensity 3.830 cd/lm Required components:</p>		
<p>OSRAM <small>Opto Semiconductors</small></p> <p>LED Oslon SSL 150 FWHM 16.0° Efficiency 87 % Peak intensity 8.100 cd/lm Required components:</p>		

PHOTOMETRIC DATA (MEASURED):

OSRAM
Opto Semiconductors

LED Oslon SSL 80
FWHM 16.0°
Efficiency 83 %
Peak intensity 6.450 cd/lm
Required components:

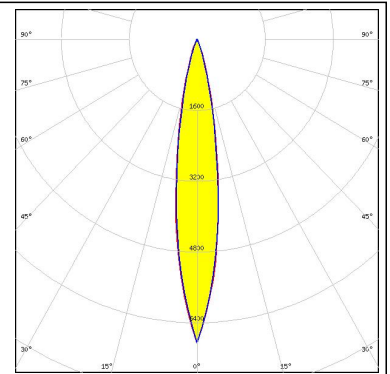
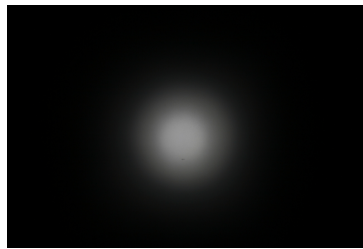

PHOTOMETRIC DATA (SIMULATED):

CREE 

LED XP-E
FWHM 15.0°
Efficiency 92 %
Peak intensity cd/lm
Required components:

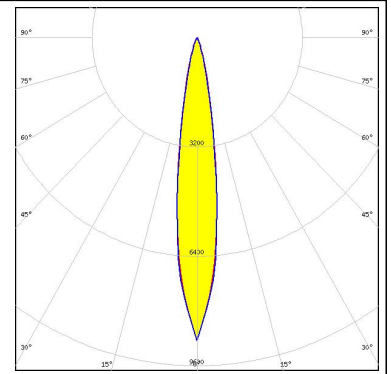

GENERAL INFORMATION:

NOTE: The typical beam angle will be changed by different color, chip size and chip position tolerance. The typical total beam angle is the full angle measured where the luminous intensity is half of the peak value.

MATERIALS:

As part of our continuous research and improvement processes, and to ensure the best possible quality and availability of our products, LEDiL reserves the right to change material grades without notice.

PRODUCT DATA USER AGREEMENT AND DISCLAIMER:

The measured data in the provided downloadable LEDiL Product Datasheets and Mechanical 2D-Drawings is rounded and provided as reference for planning. LEDiL Oy's optical specifications have been verified by conducting performance testing of the products in accordance with the company's quality system. The reported data are averaged results of multiple measurements with typical variation. LEDiL Oy reserves the right to without prior notification make changes and improvements to its products.

LEDiL Oy assumes neither warranty, nor guarantee nor any other liability of any kind for the contents and correctness of the provided data. The provided data has been generated with highest diligence but the provided data may in reality not represent the complete possible variation range of all intrinsic parameters. Therefore, in certain cases a deviation from the provided data could occur.

LEDiL Oy reserves the right to undertake technical changes of its products without further notification which could lead to changes in the provided data. LEDiL Oy assumes no liability of any kind for the possible deviation from any provided data or any other damage resulting from the usage of the provided data.

The user agrees to this disclaimer and user agreement with the download or usage of the provided files.

LEDiL Oy

Joensuunkatu 13
FI-24240 SALO
Finland

LEDiL Inc.

228 West Page Street
Suite D
Sycamore IL 60178
USA

Local sales and technical support

[www.ledil.com/
where_to_buy](http://www.ledil.com/where_to_buy)

Shipping locations

Salo, Finland
Hong Kong, China

Distribution Partners

[www.ledil.com/
where_to_buy](http://www.ledil.com/where_to_buy)