

# CRD1615-8W

## 8 Watt Reference Design

### Features

- Quasi-resonant Flyback with Constant-current Output
- Flicker-free Dimming
- Line Voltage 108VAC - 132VAC
- Rated Output Power: 7.5W
- Efficiency: ~82% at 250mA for 10×LEDs in Series
- Supports Cirrus Logic CS1615

### General Description

The CRD1615-8W reference design demonstrates the performance of the CS1615 single stage dimmable AC/DC LED driver IC with a 250mA output driving 10×LEDs in series. It offers best-in-class dimmer compatibility with leading-edge, trailing-edge, and digital dimmers. The form factor is targeted to fit into many LED bulb applications (GU10, A19, PAR, BR).

### DIMENSIONS (OVERALL)

Length	Width	Height
2.028" (51.5mm) × 1.004" (25.5mm) × 0.65" (16.5mm)		

For more information, see Figure 3 on page 6.

### ORDERING INFORMATION

CRD1615-8W-Z 8 Watt Reference Design  
Supports CS1615

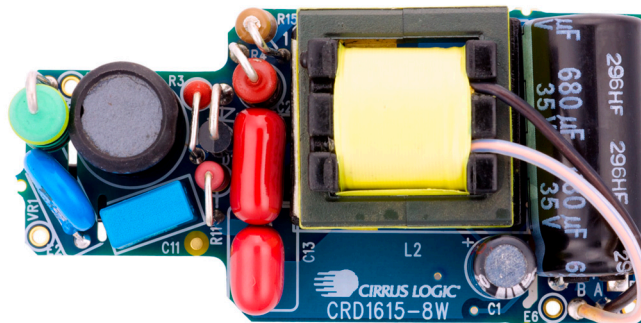

Top

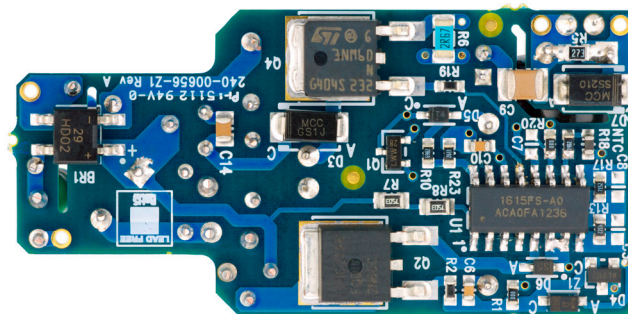

Bottom



## IMPORTANT SAFETY INSTRUCTIONS

Read and follow all safety instructions prior to using this demonstration board.

This Engineering Evaluation Unit or Demonstration Board must only be used for assessing IC performance in a laboratory setting. This product is not intended for any other use or incorporation into products for sale.

This product must only be used by qualified technicians or professionals who are trained in the safety procedures associated with the use of demonstration boards.

### **DANGER** Risk of Electric Shock

- The direct connection to the AC power line and the open and unprotected boards present a serious risk of electric shock and can cause serious injury or death. Extreme caution needs to be exercised while handling this board.
- Avoid contact with the exposed conductor or terminals of components on the board. High voltage is present on exposed conductor and it may be present on terminals of any components directly or indirectly connected to the AC line.
- Dangerous voltages and/or currents may be internally generated and accessible at various points across the board.
- Charged capacitors store high voltage, even after the circuit has been disconnected from the AC line.
- Make sure that the power source is off before wiring any connection. Make sure that all connectors are well connected before the power source is on.
- Follow all laboratory safety procedures established by your employer and relevant safety regulations and guidelines, such as the ones listed under, OSHA General Industry Regulations - Subpart S and NFPA 70E.

 **WARNING** Suitable eye protection must be worn when working with or around demonstration boards. Always comply with your employer's policies regarding the use of personal protective equipment.

 **WARNING** All components and metallic parts may be extremely hot to touch when electrically active.

---

## Contacting Cirrus Logic Support

For all product questions and inquiries contact a Cirrus Logic Sales Representative. To find the one nearest to you go to [www.cirrus.com](http://www.cirrus.com)

---

### IMPORTANT NOTICE

Cirrus Logic, Inc. and its subsidiaries ("Cirrus") believe that the information contained in this document is accurate and reliable. However, the information is subject to change without notice and is provided "AS IS" without warranty of any kind (express or implied). Customers are advised to obtain the latest version of relevant information to verify, before placing orders, that information being relied on is current and complete. All products are sold subject to the terms and conditions of sale supplied at the time of order acknowledgment, including those pertaining to warranty, indemnification, and limitation of liability. No responsibility is assumed by Cirrus for the use of this information, including use of this information as the basis for manufacture or sale of any items, or for infringement of patents or other rights of third parties. This document is the property of Cirrus and by furnishing this information, Cirrus grants no license, express or implied under any patents, mask work rights, copyrights, trademarks, trade secrets or other intellectual property rights. Cirrus owns the copyrights associated with the information contained herein and gives consent for copies to be made of the information only for use within your organization with respect to Cirrus integrated circuits or other products of Cirrus. This consent does not extend to other copying such as copying for general distribution, advertising or promotional purposes, or for creating any work for resale.

CERTAIN APPLICATIONS USING SEMICONDUCTOR PRODUCTS MAY INVOLVE POTENTIAL RISKS OF DEATH, PERSONAL INJURY, OR SEVERE PROPERTY OR ENVIRONMENTAL DAMAGE ("CRITICAL APPLICATIONS"). CIRRUS PRODUCTS ARE NOT DESIGNED, AUTHORIZED OR WARRANTED FOR USE IN PRODUCTS SURGICALLY IMPLANTED INTO THE BODY, AUTOMOTIVE SAFETY OR SECURITY DEVICES, LIFE SUPPORT PRODUCTS OR OTHER CRITICAL APPLICATIONS. INCLUSION OF CIRRUS PRODUCTS IN SUCH APPLICATIONS IS UNDERSTOOD TO BE FULLY AT THE CUSTOMER'S RISK AND CIRRUS DISCLAIMS AND MAKES NO WARRANTY, EXPRESS, STATUTORY OR IMPLIED, INCLUDING THE IMPLIED WARRANTIES OF MERCHANTABILITY AND FITNESS FOR PARTICULAR PURPOSE, WITH REGARD TO ANY CIRRUS PRODUCT THAT IS USED IN SUCH A MANNER. IF THE CUSTOMER OR CUSTOMER'S CUSTOMER USES OR PERMITS THE USE OF CIRRUS PRODUCTS IN CRITICAL APPLICATIONS, CUSTOMER AGREES, BY SUCH USE, TO FULLY INDEMNIFY CIRRUS, ITS OFFICERS, DIRECTORS, EMPLOYEES, DISTRIBUTORS AND OTHER AGENTS FROM ANY AND ALL LIABILITY, INCLUDING ATTORNEYS' FEES AND COSTS, THAT MAY RESULT FROM OR ARISE IN CONNECTION WITH THESE USES.

Cirrus Logic, Cirrus, the Cirrus Logic logo designs, EXL Core, and the EXL Core logo design are trademarks of Cirrus Logic, Inc. All other brand and product names in this document may be trademarks or service marks of their respective owners.

## 1. INTRODUCTION

The CS1615 is a 120VAC quasi-resonant flyback mode dimmable LED controller IC. The CS1615 uses a digital control algorithm that is optimized for high efficiency and  $>0.9$  power factor over an input voltage range (108VAC to 132VAC). The CS1615 integrates a dimmer compatibility circuit with a constant output current, quasi-resonant flyback stage. An adaptive dimmer compatibility algorithm controls the dimmer compatibility operation mode to enable flicker-free operation from 0% to 100% output current with leading-edge, trailing-edge, and digital dimmers.

The CRD1615-8W board is optimized to deliver low system cost in a high-efficiency, flicker-free, phase-dimmable, solid-state lighting (SSL) solution for incandescent lamp replacement applications. The feedback loop is closed through an integrated digital control system within the IC. Protection algorithms such as output open/short, current-sense resistor open/short, and overtemperature thermistors protect the system during abnormal conditions. When using the CS1615 for a design that does not require active clamp circuitry, the CLAMP pin should be left floating. Details of these features are provided in the CS1615/16 data sheet DS961 *Single Stage Dimmable Offline AC/DC Controller for LED Lamps*.

The CRD1615-8W board demonstrates the performance of the CS1615. This reference board has been designed for an output load of 10×LEDs in series at 250mA (~28.0V typical).

This document provides the schematic for the board. It includes oscilloscope screen shots that indicate various operating waveforms. Graphs are also provided that document the performance of the board in terms of Efficiency vs. Line Voltage, Output Current vs. Line Voltage, and Output Current vs. Dim Angle for the CS1615 dimmable LED controller IC.

Extreme caution needs to be exercised while handling this board. This board is to be used by trained professionals only.

2. SCHEMATIC

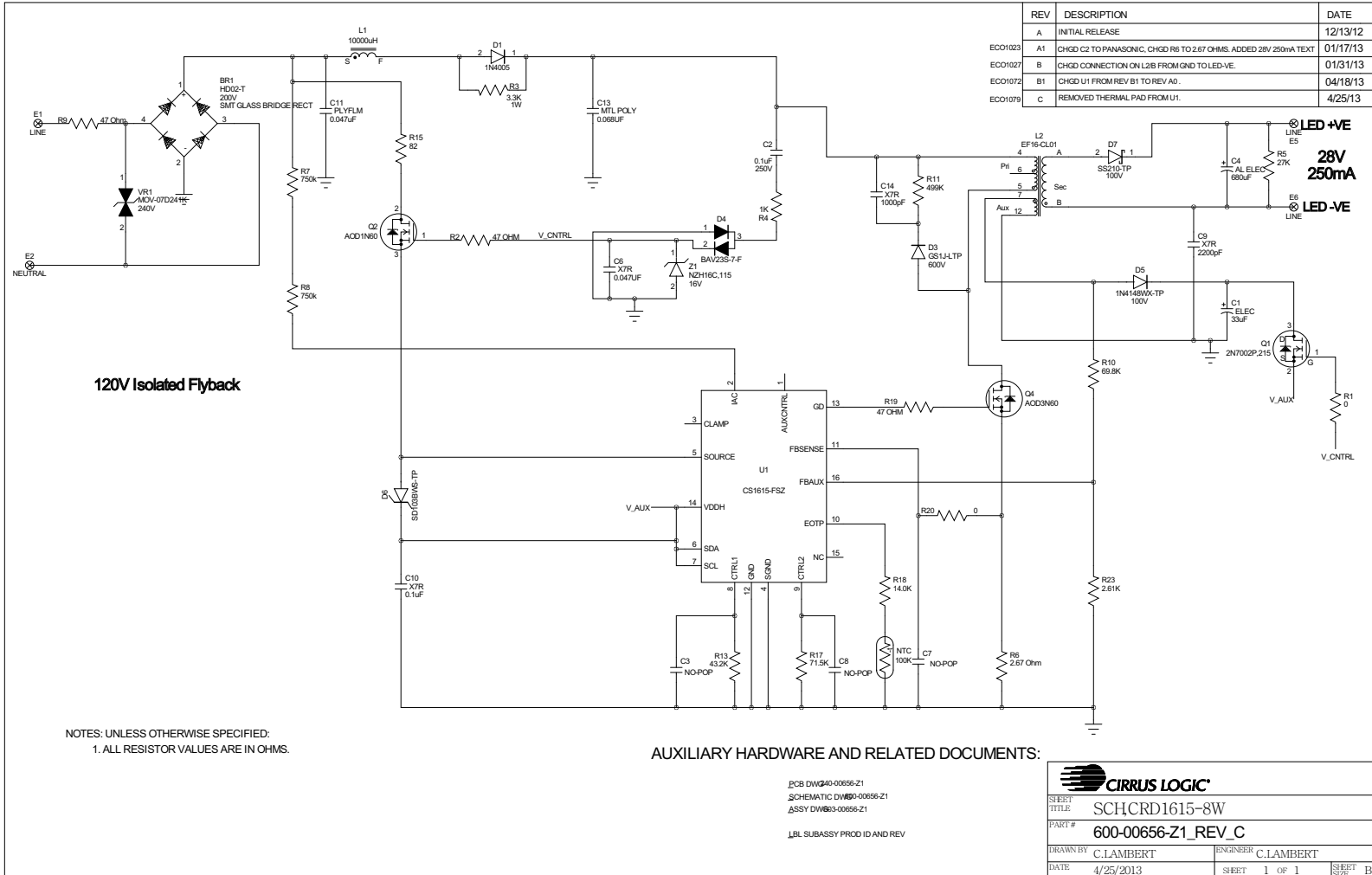

Figure 1. Schematic

**3. BILL OF MATERIALS**

Item	Rev	Description	Qty	Reference Designator	MFG	MFG P/N
1		DIODE RECT 200V 0.8A NPb MINIDIP	1	BR1	DIODES INC	HD02-T
2		CAP 33uF ±20% 35V ALUM ELEC NPb RAD	1	C1	PANASONIC	ECA1VHG330
3		CAP 0.1uF ±10% 250V MPET NPb RAD	1	C2	PANASONIC	ECQE2104KF
4		CAP 56pF ±5% 50V COG NPb 0603	2	C3 C8	KEMET	NP-C0603C560J5GAC
5		CAP 680uF ±20% 35V AL ELEC NPb RAD	1	C4	PANASONIC	EEUFR1V681
6	A	CAP 0.047uF ±10% 25V X7R NPb 0603	1	C6	KEMET	C0603C473K3RAC
7		CAP 100pF ±5% 50V COG NPb 0603	1	C7	KEMET	NP-C0603C101J5GAC
8		CAP 2200pF ±10% 2KV X7R NPb 1210	1	C9	KEMET	C1210C222KGRAC
9		CAP 0.1uF ±10% 25V X7R NPb 0603	1	C10	KEMET	C0603C104K3RAC
10		CAP 0.047uF ±5% 250V POLY NPb RAD	1	C11	EPCOS	B32529C3473J
11		CAP 0.068uF ±10% 250V MPOLY NPb RAD	1	C13	PANASONIC	ECQE2683KB
12		CAP 1000PF ±10% 500V X7R NPb 0805	1	C14	KEMET	C0805C102KCRAC
13		DIODE RECT 600V 1A 50mA NPb DO-41	1	D1	DIODES INC	1N4005
14		DIODE 600V 1A NPb SMA DO-214AC	1	D3	MCC	GS1J-LTP
15		DIODE SWT 250V 0.4A NPb SOT-23	1	D4	DIODES INC	BAV23S-7-F
16		DIODE HS SWT 100V 300mA NPb SOD323	1	D5	MICRO COMMERCIAL	1N4148WX-TP
17		DIODE SCHOTTKY 350mA 30V NPb SOD323	1	D6	MICRO COMMERCIAL	SD103BWS-TP
18		DIODE SKY RECT 100V 2A NPb DO-214AC	1	D7	MCC	SS210-TP
19		NO POP PAD H40 P64 NPb TH	4	E1 E2 E5 E6	NO POP	NP-PAD-H40P64
20		IND 10000uH 0.053A MINI-DRUM NPb TH	1	L1	RENCO	RL-5480-3-10000
21		XFMR 2.6mH ±10% 10KHz NPb TH	1	L2	KUNSHAN EAGERNESS	EF16-CL01
22		THERM 100K OHM ±5% 0.10mA NPb 0603	1	NTC	MURATA	NCP18WF104J03RB
23		TRAN MSFET nCH 60V 360mA NPb SOT-23	1	Q1	NXP	2N7002P,215
24		TRAN MOSFET nCH 1.3A 600V NPb DPAK	1	Q2	ALPHA & OMEGA	AOD1N60
25		TRAN MOSFET nCH 2.5A 600V NPb DPAK	1	Q4	ALPHA & OMEGA	AOD3N60
26		RES 0 OHM 1/10W ±5% NPb 0603 FILM	2	R1 R20	DALE	CRCW06030000Z0EA
27		RES 47 OHM 1/10W ±1% NPb 0603	2	R2 R19	PANASONIC	ERJ3EK4F7R0V
28		RES 3.3K OHM 1W ±5% NPb AXL	1	R3	BC COMPONENTS	PR01000103301JR500
29		RES 1k OHM 2W ±5% MTL FLM NPb AXL	1	R4	VISHAY	PR02000201001JR500
30		RES 27K OHM 1/8W ±0.1% NPb 0805	1	R5	PANASONIC	ERA-6YEB273V
31		RES 2.67 OHM 1/4W ±1% NPb 1206	1	R6	KOA	RK73H2BTTD2R67F
32		RES 750k OHM 1/8W ±1% NPb 0805 FILM	2	R7 R8	PANASONIC	ERJ6ENF7503V
33		RES 470OHM 2W 1% FUSIBLE MTL NPb AX	1	R9	YAGEO	FKN2WSFTF73-47R
34		RES 69.8k OHM 1/10W ±1% NPb 0603	1	R10	DALE	CRCW060369K8FKEA
35		RES 499K OHM 1/4W ±1% MTL NPb AXL	1	R11	VISHAY	CCF55499KFKE36
36		RES 43.2k OHM 1/10W ±1% NPb 0603	1	R13	DALE	CRCW060343K2FKEA
37		RES 82 OHM 1/2W ±5% C FLM NPb AXL	1	R15	KOA	CF1/2CT52R820J
38		RES 71.5k OHM 1/10W ±1% NPb 0603	1	R17	DALE	CRCW060371K5FKEA
39		RES 14k OHM 1/10W ±1% NPb 0603 FILM	1	R18	DALE	CRCW060314K0FKEA
40		RES 2.61k OHM 1/10W ±1% NPb 0603	1	R23	DALE	CRCW06032K61FKEA
41	A0	IC CRUS TRIAC DIM PFC 120V NPb SO16	1	U1	CIRRUS LOGIC	CS1615-FSZ/A0
42		VARISTOR 240V 210pF 15J 7mm NPb RAD	1	VR1	BOURNS	MOV-07D241K
43		DIODE ZENER 500mW 16V NPb SOD123F	1	Z1	NXP	NZH16C,115

**Figure 2. Bill of Materials**

### 4. BOARD LAYOUT

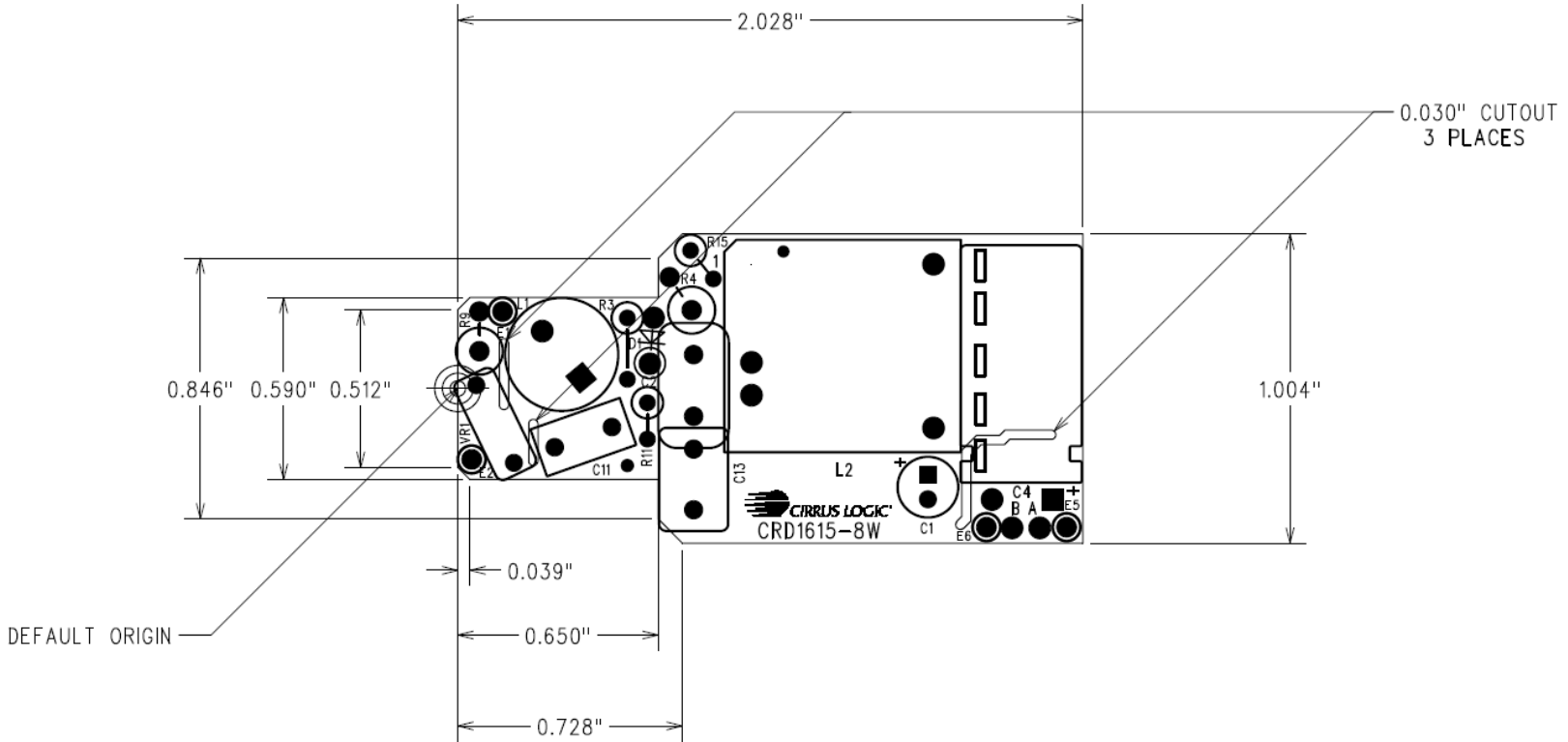

Figure 3. PCB Dimensions

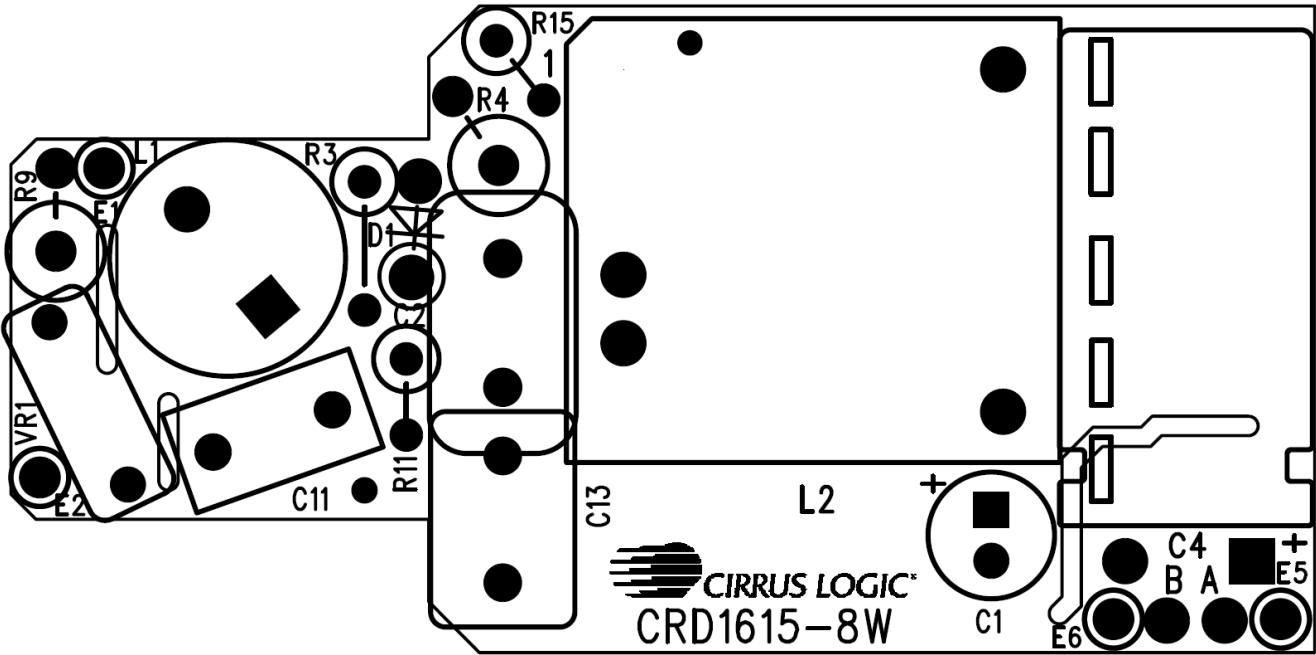

Figure 4. Top Silkscreen

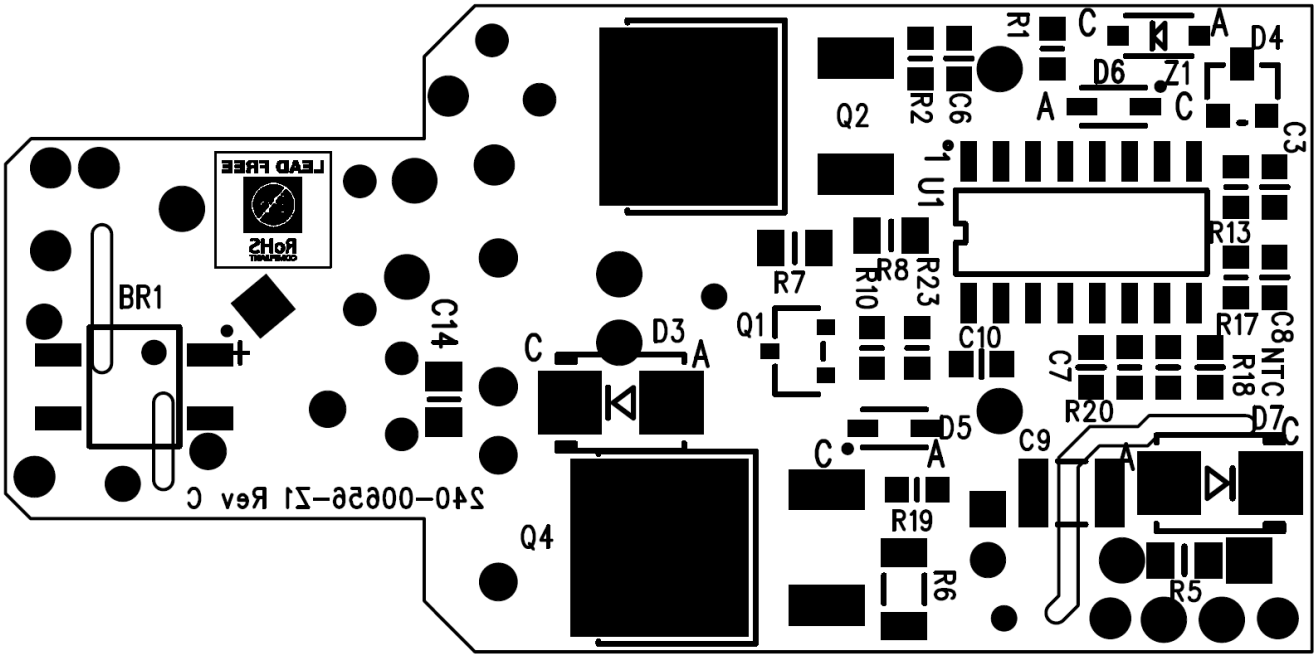

Figure 5. Bottom Silkscreen



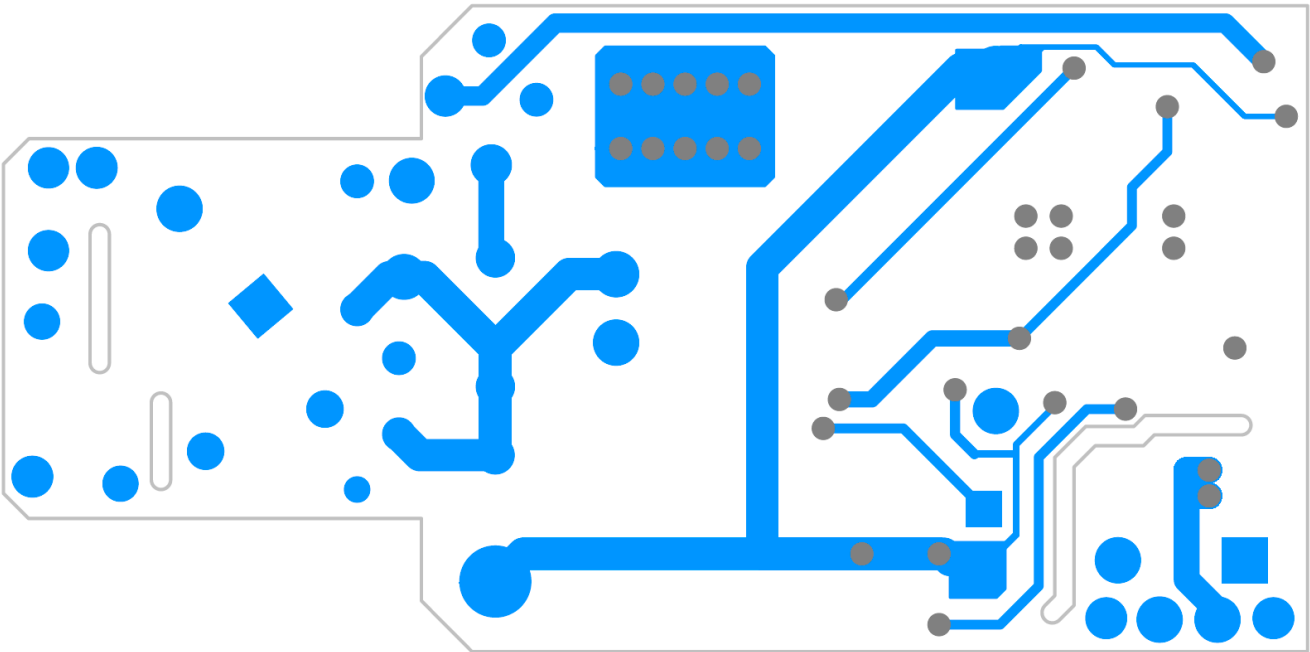

Figure 6. Top Routing

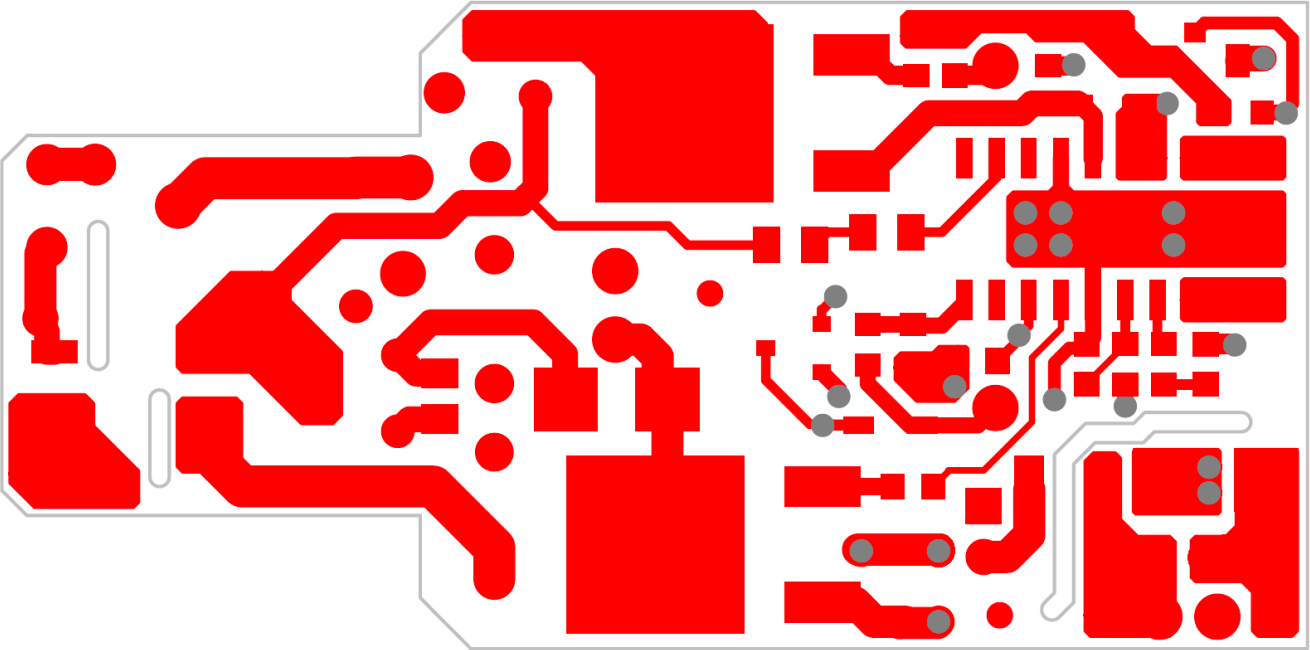

Figure 7. Bottom Routing

5. THERMAL IMAGING

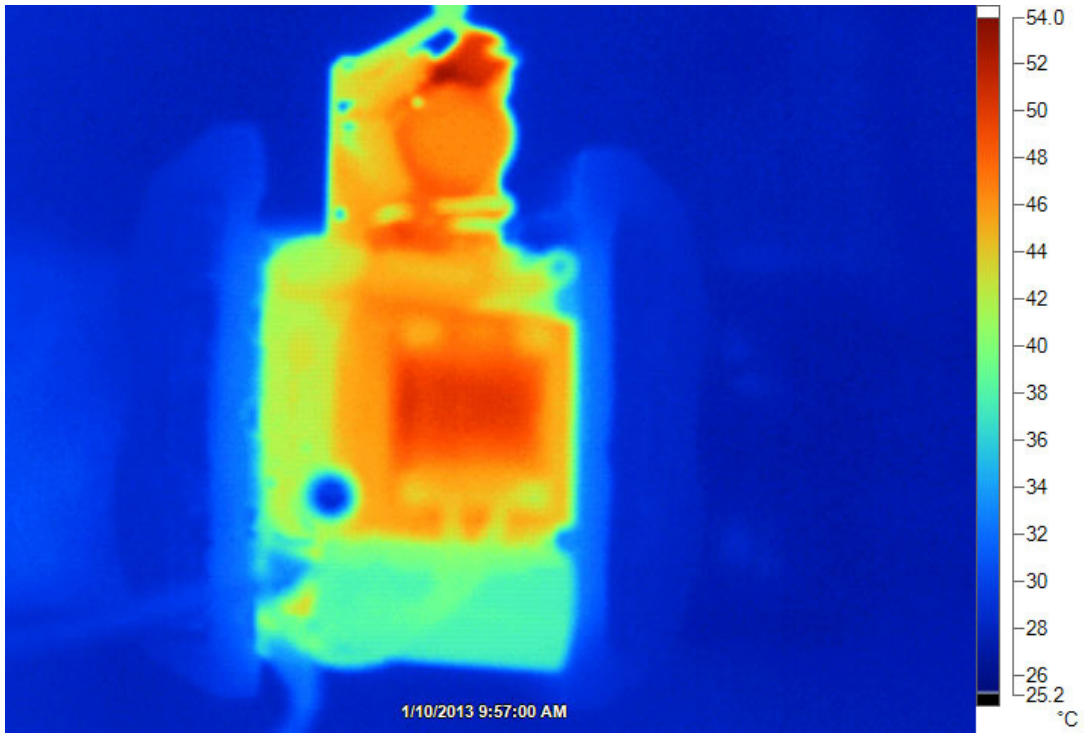

Figure 8. Top Thermal

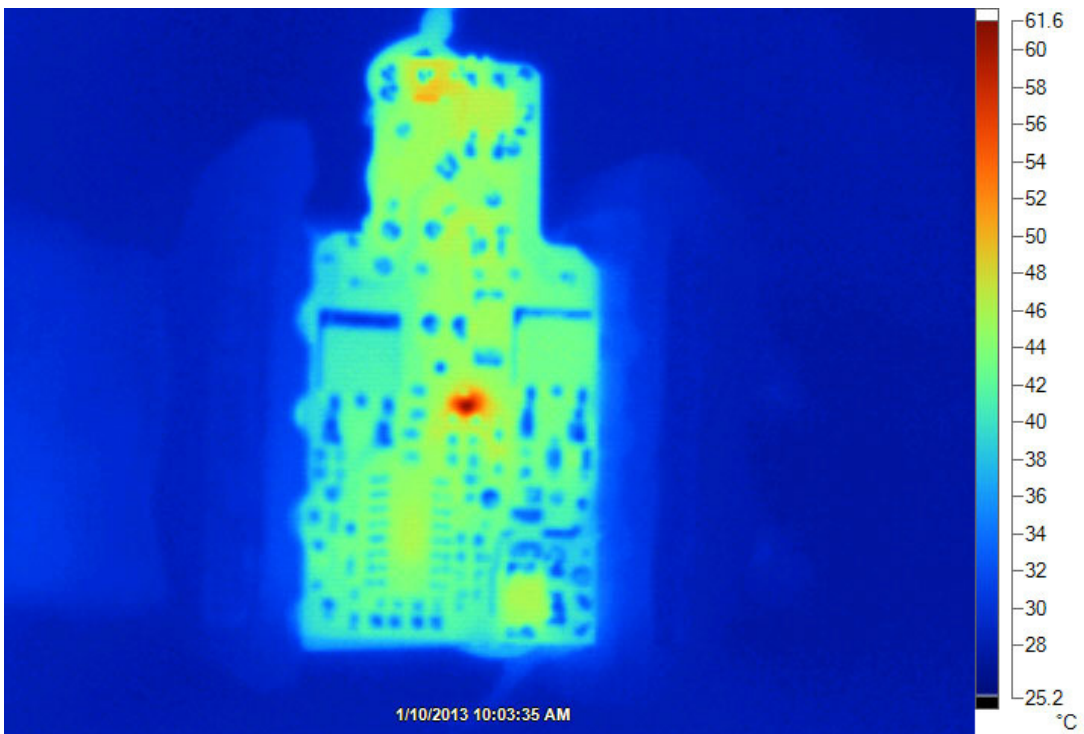

Figure 9. Bottom Thermal

**6. DIMMER COMPATIBILITY - A19 WITH CS1615 (108V - 132V)**

Input Power	<b>8.3W</b>	Dimmer Compatibility	<b>1116/1200</b>	Efficiency	<b>82%</b>
-------------	-------------	----------------------	------------------	------------	------------

Date	1/8/2013	Power Factor <sup>1,5</sup>	0.99
Vendor	Cirrus Logic	EN55015 Compliant (Y/N)	Y
Input Voltage/Frequency	120V/60Hz	Nominal Input Power (W) <sup>1,5</sup>	8.3
Form Factor	A19	Maximum Input Power (W) <sup>2,5</sup>	8.5
Model #	CRD1615-8W	Output Voltage (V) <sup>1,3</sup>	27.8
IC	CS1615	Output Current (mA) <sup>1,3</sup>	244
Topology	Flyback	Output Current Ripple ≤ 120Hz (mA <sub>p-p</sub> ) <sup>1,4</sup>	200
Isolation (Y/N)	Y	Output Power (W) <sup>1,5</sup>	6.8
Compatibility Spec	1.0	Efficiency (%)	82

Dimmer Type	Flicker Free Steady-State			Monotonic Dimming			Max I <sub>OUT</sub> (mA)			Min I <sub>OUT</sub> (mA)			TOTAL
	# of lamps			# of lamps			# of lamps			# of lamps			
	1	5	10	1	5	10	1	5	10	1	5	10	
Cooper - Leading Edge	Y	Y	Y	Y	Y	Y	248	248	248	1	1	1	24
Cooper - Leading Edge	Y	Y	Y	Y	Y	Y	248	248	248	1	1	1	24
Cooper - Leading Edge	Y	Y	Y	Y	Y	Y	245	244	244	1	1	1	24
GE - Leading Edge	Y	Y	Y	Y	Y	Y	248	248	248	1	1	1	24
Leviton - Leading Edge	Y	Y	Y	Y	Y	Y	249	249	249	1	1	1	24
Leviton - Leading Edge	Y	Y	Y	Y	Y	Y	248	248	248	1	1	1	24
Leviton - Trailing Edge	Y	Y	Y	N	N	N	245	245	246	3	3	1	21
Leviton - Leading Edge	Y	Y	Y	Y	Y	Y	249	249	249	17	16	16	21
Leviton - Leading Edge	Y	Y	Y	Y	Y	Y	250	248	249	1	1	1	24
Leviton - Leading Edge	Y	N	Y	Y	Y	Y	249	249	249	1	1	1	19
Leviton - Leading Edge	Y	Y	Y	Y	Y	Y	249	249	249	1	1	1	24
Leviton - Leading Edge	Y	Y	Y	Y	Y	Y	246	246	246	1	1	1	24
Leviton - Leading Edge	Y	Y	Y	Y	Y	Y	246	246	246	1	1	1	24
Leviton - Leading Edge	Y	Y	Y	Y	Y	Y	246	246	246	1	1	1	24
Leviton - Trailing Edge	Y	Y	Y	Y	Y	Y	246	245	245	1	1	1	24
Leviton - Leading Edge	Y	Y	Y	N	Y	Y	249	249	249	1	1	1	23
Leviton - Leading Edge	Y	Y	Y	Y	Y	Y	249	249	249	13	13	12	22
Leviton - Leading Edge	Y	Y	Y	Y	Y	Y	248	248	248	1	1	1	24
Leviton - Leading Edge	Y	Y	Y	Y	Y	Y	248	248	248	1	1	1	24
Leviton - Leading Edge	Y	Y	Y	Y	Y	Y	249	249	249	1	1	1	24
Leviton - Motion Detect	Y	N	N	Y	Y	Y	249	248	248	0	0	0	14
Leviton - Leading Edge	Y	Y	N	Y	Y	Y	249	249	249	1	1	1	19
Lutron - Leading Edge	Y	Y	Y	Y	Y	Y	248	248	248	1	1	1	24

Dimmer Type	Flicker Free Steady-State			Monotonic Dimming			Max I <sub>OUT</sub> (mA)			Min I <sub>OUT</sub> (mA)			TOTAL
	# of lamps			# of lamps			# of lamps			# of lamps			
	1	5	10	1	5	10	1	5	10	1	5	10	
Lutron - Leading Edge	Y	Y	Y	N	N	N	249	249	249	1	1	1	21
Lutron - Leading Edge	Y	Y	Y	Y	Y	Y	249	249	249	4	3	3	24
Lutron - Leading Edge	Y	Y	Y	Y	Y	Y	249	249	249	1	1	1	24
Lutron - Leading Edge	Y	Y	Y	Y	Y	Y	249	249	249	1	1	1	24
Lutron - Trailing Edge	Y	Y	Y	Y	Y	Y	221	225	224	3	3	1	21
Lutron - Leading Edge	Y	Y	Y	Y	Y	Y	249	248	248	1	1	1	24
Lutron - Leading Edge	Y	Y	Y	Y	Y	Y	249	249	249	1	1	1	24
Lutron - Leading Edge	Y	Y	Y	Y	Y	Y	240	240	240	1	1	1	24
Lutron - Leading Edge	Y	Y	Y	Y	Y	Y	249	249	249	1	1	1	24
Lutron - Leading Edge	Y	Y	Y	Y	Y	Y	248	248	248	1	1	1	24
Lutron - Leading Edge	Y	Y	N	Y	Y	Y	249	249	249	1	1	1	19
Lutron - Occupancy Sensor	Y	Y	Y	Y	Y	Y	244	244	244	0	0	0	24
Lutron - Leading Edge	Y	Y	Y	Y	Y	Y	249	249	249	13	12	1	23
Lutron - Trailing Edge	N	N	N	Y	Y	Y	-	-	-	3	3	1	6
Lutron - Leading Edge	Y	Y	Y	Y	Y	Y	248	248	248	1	1	1	24
Lutron - Leading Edge	Y	Y	Y	Y	Y	Y	249	249	249	1	1	1	24
Lutron - Leading Edge	Y	Y	Y	Y	Y	Y	249	249	249	1	1	1	24
Lutron - Trailing Edge	Y	Y	Y	Y	Y	Y	190	190	195	1	1	1	21
Lutron - Leading Edge	Y	Y	Y	Y	Y	Y	249	249	249	1	1	1	24
Lutron - Leading Edge	Y	Y	Y	Y	Y	Y	249	249	249	1	1	1	24
Lutron - Leading Edge	Y	Y	N	N	Y	Y	249	250	-	13	13	1	16
Lutron - Leading Edge	Y	N	N	Y	Y	Y	249	249	-	15	15	1	12
Lutron - Leading Edge	Y	Y	Y	Y	Y	Y	249	249	249	1	1	1	24
Lutron - Leading Edge	Y	Y	Y	Y	N	N	249	249	249	1	1	1	22
Lutron - Leading Edge	Y	Y	Y	Y	Y	Y	249	249	249	1	1	1	24
Pass & Seymour - Occupancy Sensor	Y	Y	Y	Y	Y	Y	247	246	247	0	0	0	24
Smarthome - Leading Edge	Y	Y	Y	Y	Y	Y	249	248	249	1	1	1	24
<b>Overall Total</b>												<b>1116</b>	

- Notes:
1. Tested at nominal input voltage, nominal input frequency and without a dimmer after soaking for 15 minutes
  2. Compliant with IEC 61000-3-2 Class C < 25W
  3. Average
  4. Peak-to-peak
  5. Measured with Chroma 66202 Power Analyzer

## 7. TRANSFORMER CONSTRUCTION

The CRD1615-8W provides power factor correction and dimmer compatibility with a constant output current, quasi-resonant flyback stage. The following sections describe the flyback transformer installed on the CRD1615-8W.

### 7.1 Flyback Transformer

The flyback transformer stage is a quasi-resonant peak current-regulated DC-DC converter capable of delivering the highest possible efficiency with constant current output while minimizing line frequency ripple. The auxiliary winding is used for zero-current detection and overvoltage protection.

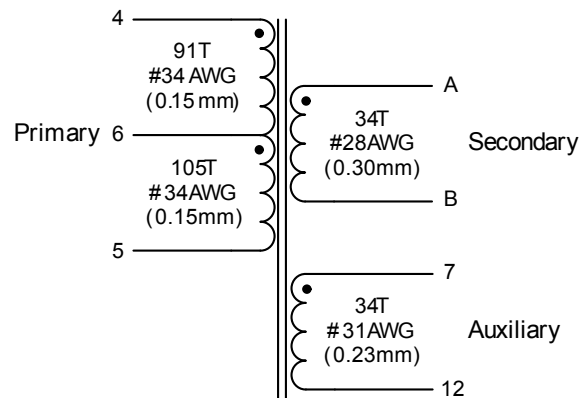

**Figure 10. Flyback Transformer Schematic**

#### 7.1.1 Electrical Specifications

Characteristics conditions:

- Operating temperature range: -25 °C to +120 °C (including coil heat)

Parameter	Condition	Symbol	Min	Typ	Max	Unit
<b>Flyback Transformer</b>						
Electrical Strength	(Note 1) $f_{operate}=50/60\text{Hz}$		-	3.75	-	kV <sub>RMS</sub>
Primary Inductance	(Note 2) $f_{resonant}=10\text{kHz}$ , 0.3V at 20°C	$L_P$	2.34	2.6	2.86	mH
Primary Leakage Inductance	(Note 2) $f_{resonant}=10\text{kHz}$ , 0.3V at 20°C	$L_K$	-	-	55	μH
Primary DC Resistance	(Note 2) $t_{DCR}=20^\circ\text{C}$		4.64	5.8	6.96	Ω
Secondary DC Resistance	(Note 3) $t_{DCR}=20^\circ\text{C}$		0.208	0.26	0.312	mΩ
Auxiliary DC Resistance	(Note 4) $t_{DCR}=20^\circ\text{C}$		0.44	0.55	0.66	mΩ

- Notes:
1. Time = 2sec.
  2. Measured across pins 4 and 5.
  3. Measured across pins B and A.
  4. Measured across pins 12 and 7.

## 8. PERFORMANCE PLOTS

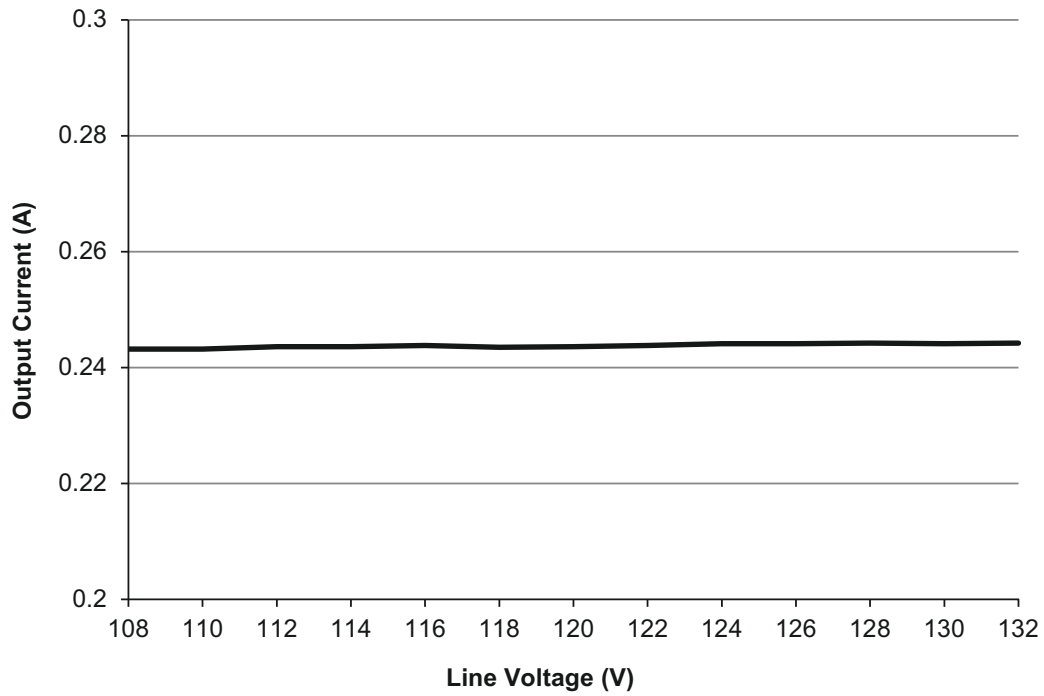

Figure 11. Output Current vs. Line Voltage

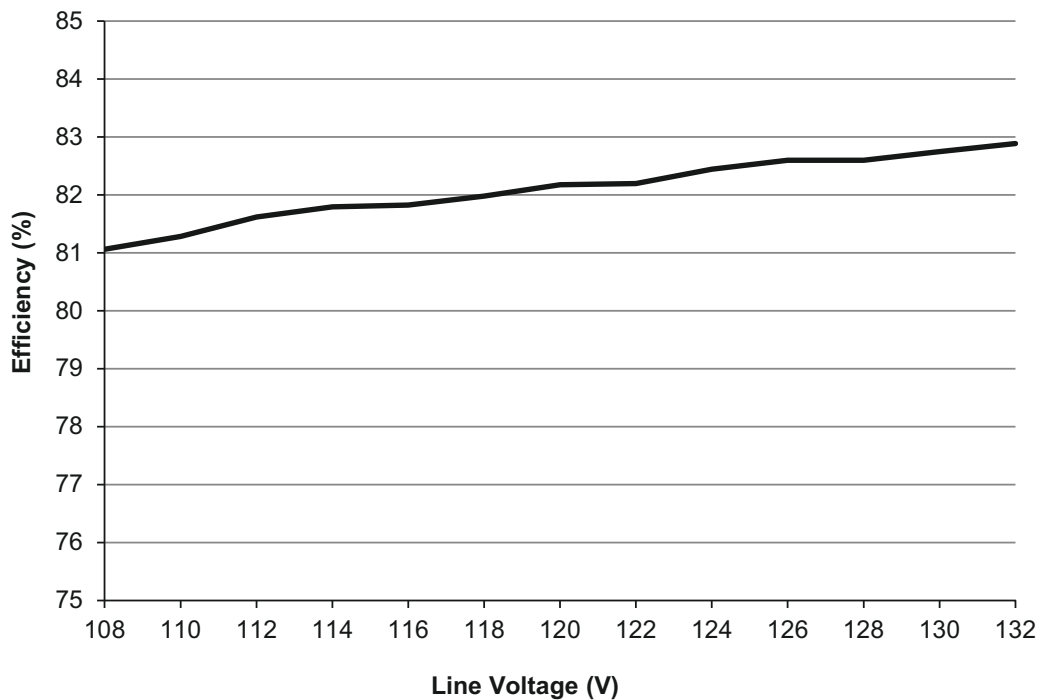

Figure 12. Typical Efficiency vs. Line Voltage

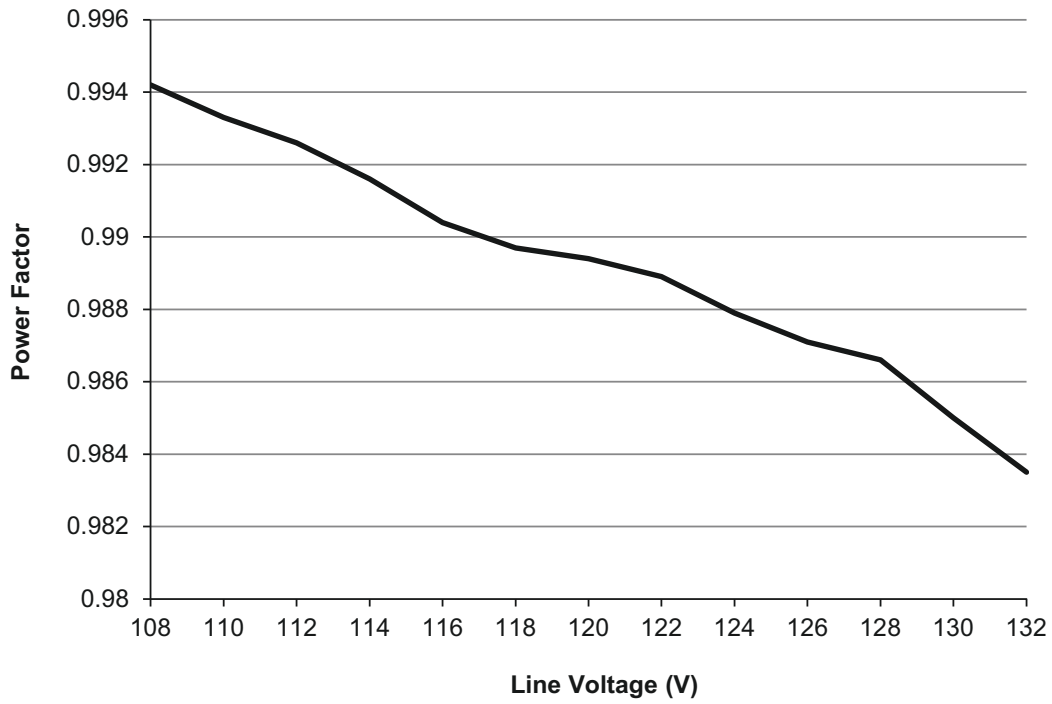

Figure 13. Power Factor vs. Line Voltage

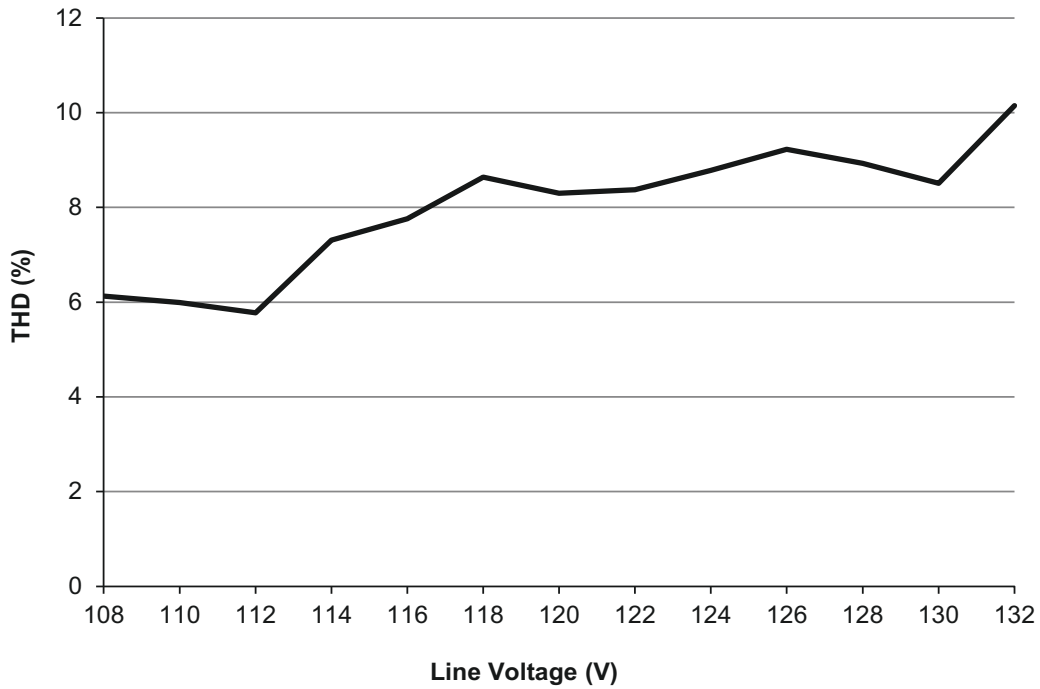

Figure 14. THD vs Line Voltage



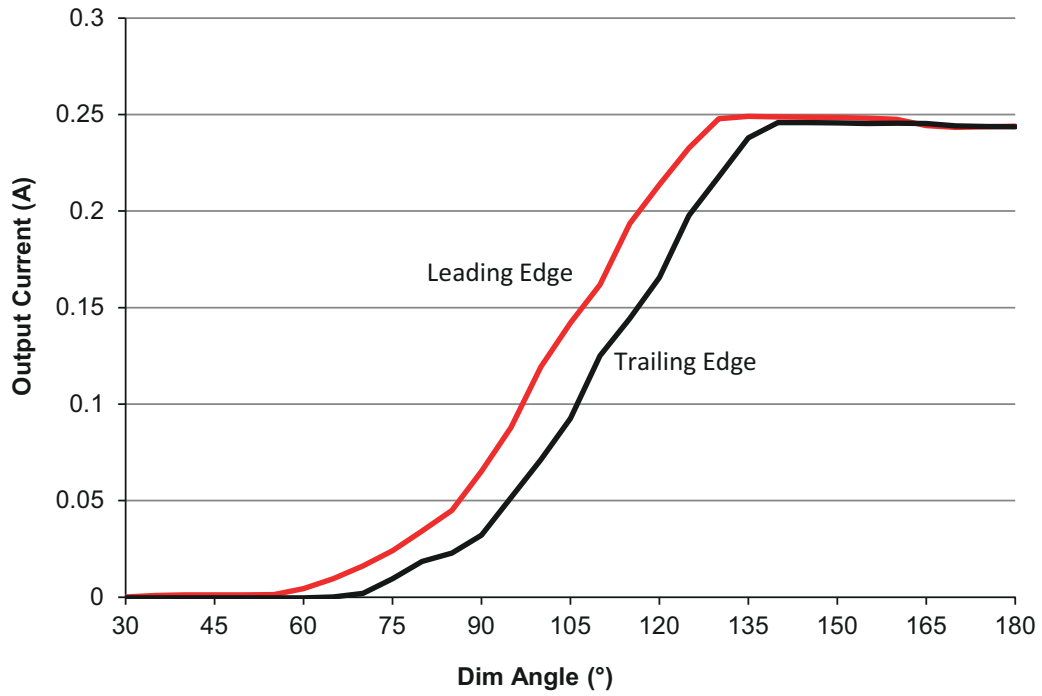
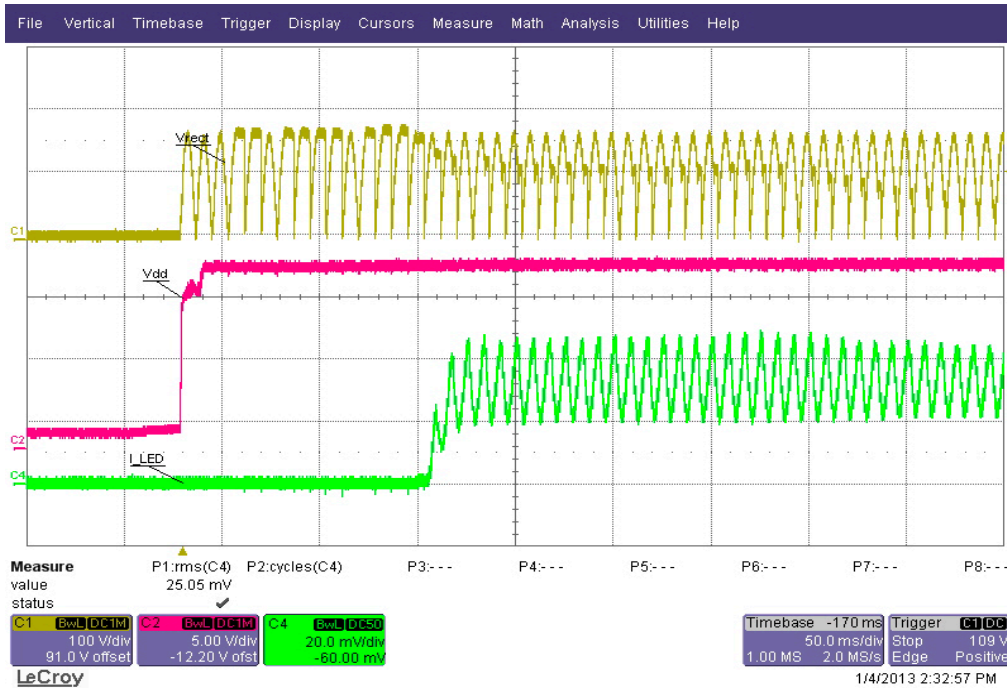
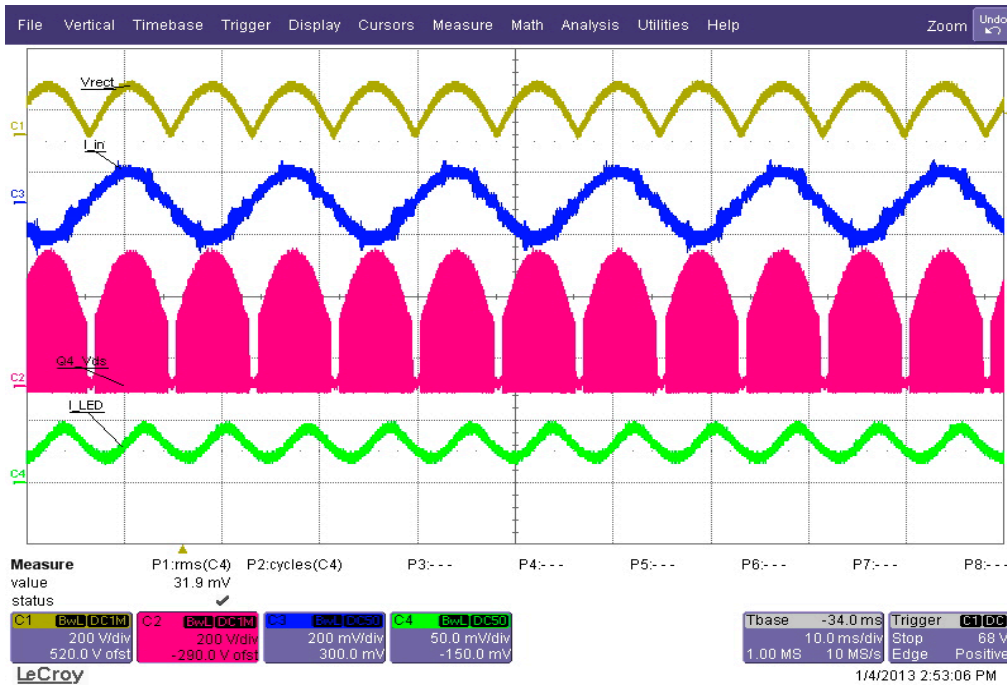
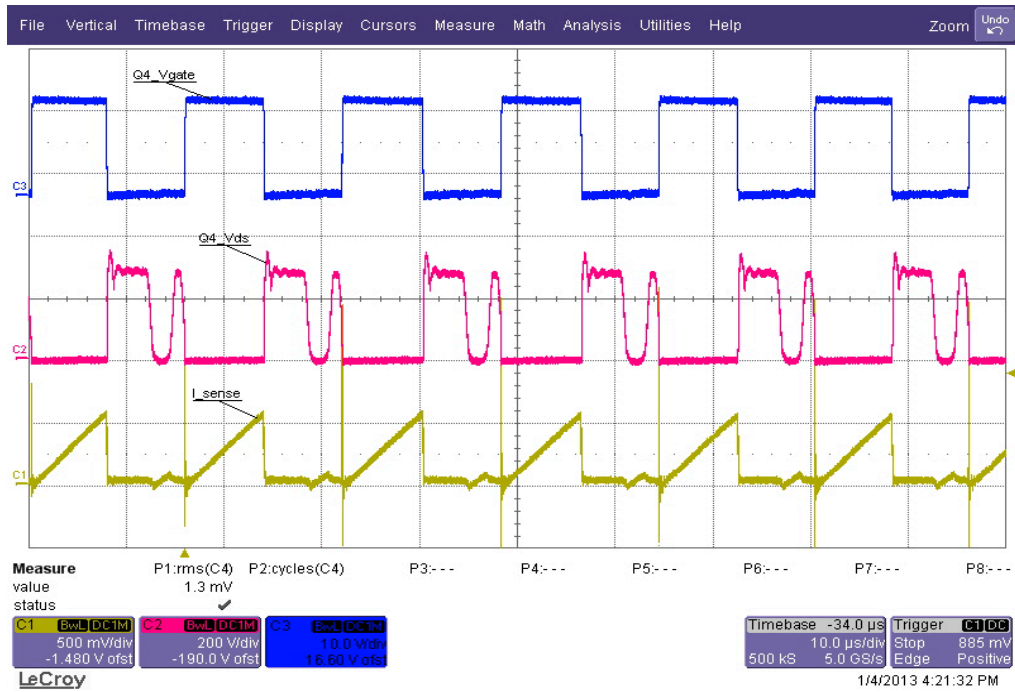
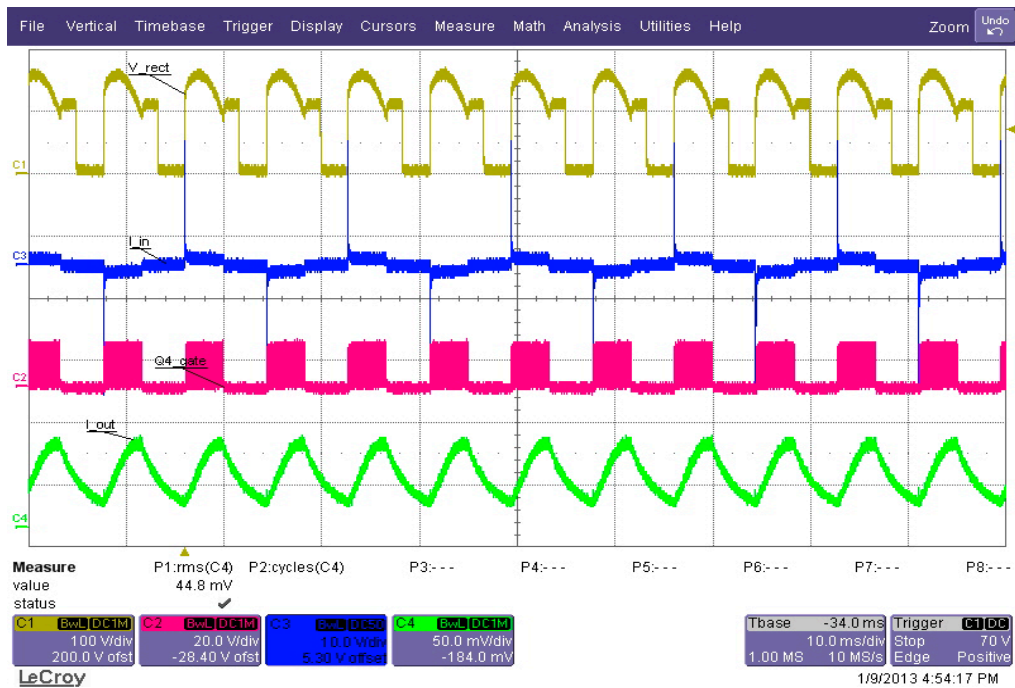
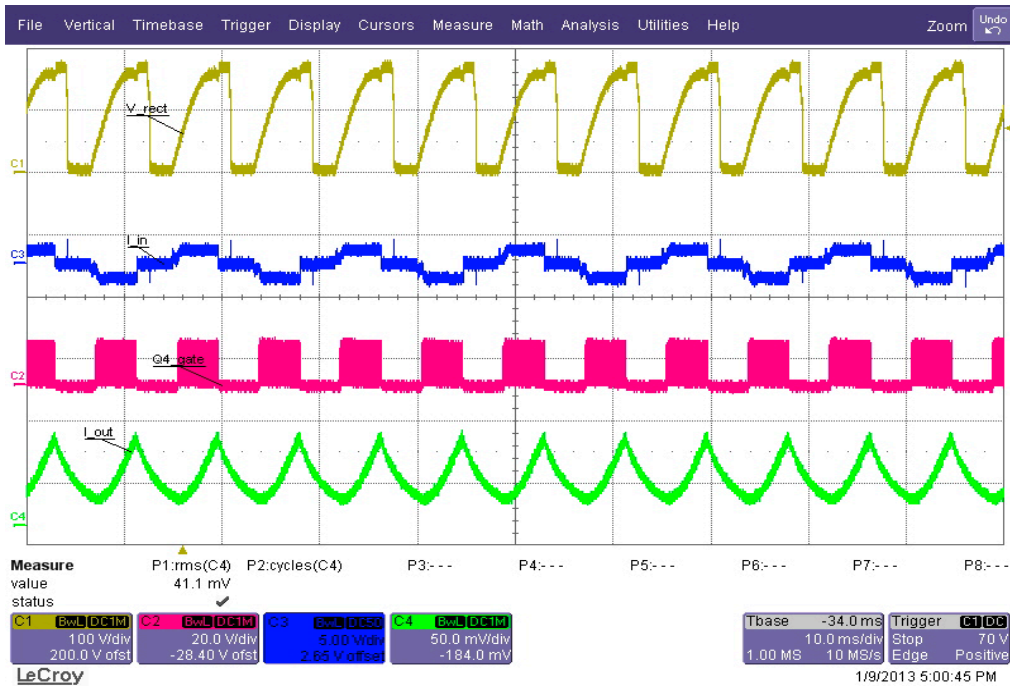

Figure 15. Typical Output Current vs Dim Angle

**Figure 16. No-dimmer Mode, Startup, 120 VAC**

**Figure 17. No-dimmer Mode, Steady-state, 120 VAC**

**Figure 18. Flyback FET Q4, 120VAC**

**Figure 19. Leading-edge Dimmer Mode, Steady-state, 120VAC**



**Figure 20. Trailing-edge Dimmer Mode, Steady-state, 120VAC**

**9. CONDUCTED EMI**
**Device Under Test:** CRD1615-8W-Z

**Operating Conditions:** NOMINAL

**Test Specification:** EN55022:2010

**Operator Name:** CAL

**Scan Settings (1 Range)**

Frequencies			Receiver Settings			
Start	Stop	Step	Res BW	M-Time	Atten	Preamp
150kHz	30MHz	4.5kHz	9kHz (6dB)	50ms	Auto	Off

**Final Measurement**
**Detectors:** QP, AV

**Peaks:** 10

**Meas Time:** See scan settings

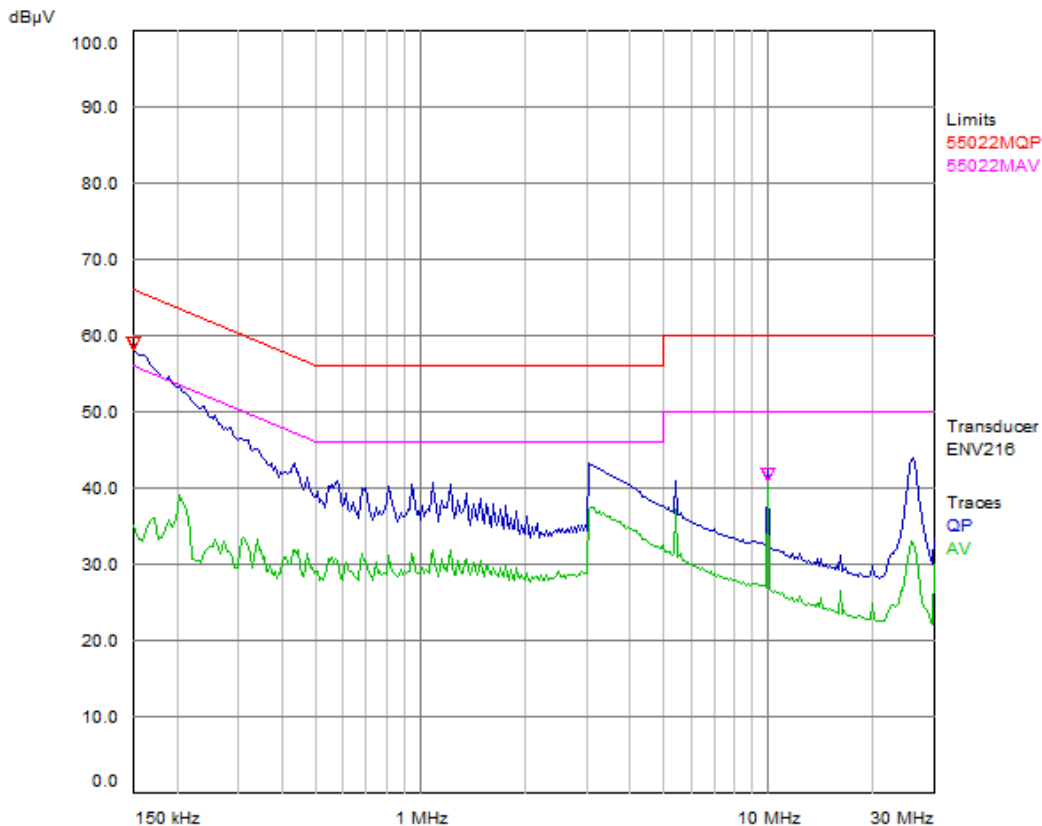
**Acc. Margin:** 12dB

**Figure 21. Conducted EMI**
**Final Measurement Results**

Trace	Frequency (MHz)	Level (dBµV)	Limit (dBµV)	Delta Limit (dB)	Delta Ref (dB)	Comment
1QP	0.15	58.05	66.00	-7.95		N/on
2AV	10.0005	41.04	50.00	-8.96		N/on

\* = Limit Exceeded

**10. REVISION HISTORY**

<b>Revision</b>	<b>Date</b>	<b>Changes</b>
RD1	FEB 2013	Final release
RD2	APR 2013	Context clarification
RD3	JUL 2013	Content updated using PCBA Rev C