

ZERO RECOVERY™ RECTIFIER

Features

- 300 Volt Schottky Rectifier
- Zero Reverse Recovery
- Zero Forward Recovery
- High Frequency Operation
- Temperature Independent Switching Behavior
- Extremely Fast Switching
- Positive Temperature Coefficient on V_F

Benefits

- Replace Bipolar with Unipolar Rectifiers
- Essentially No Switching Losses
- Higher Efficiency
- Reduction Of Heat Sink Requirements
- Parallel Devices without Thermal Runaway

Applications

- Switch Mode Power Supplies
- Power Factor Correction
- Motor Drives
- Output Rectification

Package

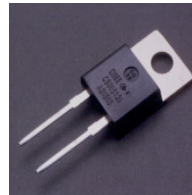

CSD10030A

Maximum Ratings

Parameter	Symbol	Value	Unit
Repetitive Peak Reverse Voltage	V_{RRM}	300	V
Surge Peak Reverse Voltage	V_{RSM}	300	V
DC Blocking Voltage	V_{DC}	300	V
Average Forward Current $T_C=150\text{ }^\circ\text{C}$	$I_{F(AV)}$	10	A
Repetitive Peak Forward Surge Current $T_C=25\text{ }^\circ\text{C}$, $t_p=8.3\text{ms}$, Half Sine Wave	I_{FRM}	40	A
Non-Repetitive Peak Forward Surge Current $T_C=25\text{ }^\circ\text{C}$, $t_p=10\mu\text{s}$, Pulse	I_{FSM}	200	A
Power Dissipation $T_C = 25\text{ }^\circ\text{C}$	P_{tot}	79	W
Operating Junction and Storage Temperature	T_J, T_{stg}	-55 to +175	$^\circ\text{C}$

ELECTRICAL CHARACTERISTICS

Parameter	Symbol	Min	Typ	Max	Units
Forward Voltage $I_F = 10A$ $T_J = 25^\circ C$ $I_F = 10A$ $T_J = 175^\circ C$	V_F		1.2 1.4	1.4 1.8	V
Reverse Current $V_R = 300V$ $T_J = 25^\circ C$ $V_R = 300V$ $T_J = 175^\circ C$	I_R		50 1000	200 2000	μA
Total Capacitive Charge $V_R = 300V, I_F = 10A, di/dt = 500 A/\mu s, T_J = 25^\circ C$	Q_C		11.5		nC
Total Capacitance $V_R = 0V, T_J = 25^\circ C, f = 1MHz$ $V_R = 150V, T_J = 25^\circ C, f = 1MHz$ $V_R = 300V, T_J = 25^\circ C, f = 1MHz$	C		660 62 58		pF

NOTE:

1. This is a majority carrier diode, so there is no reverse recovery charge.

THERMAL CHARACTERISTICS

Characteristic	Symbol	Min	Typ	Max	Units
Thermal Resistance from Junction to Case	$R_{\theta JC}$		1.9		$^\circ C/W$

Typical Performance

Figure 1. Forward Characteristics

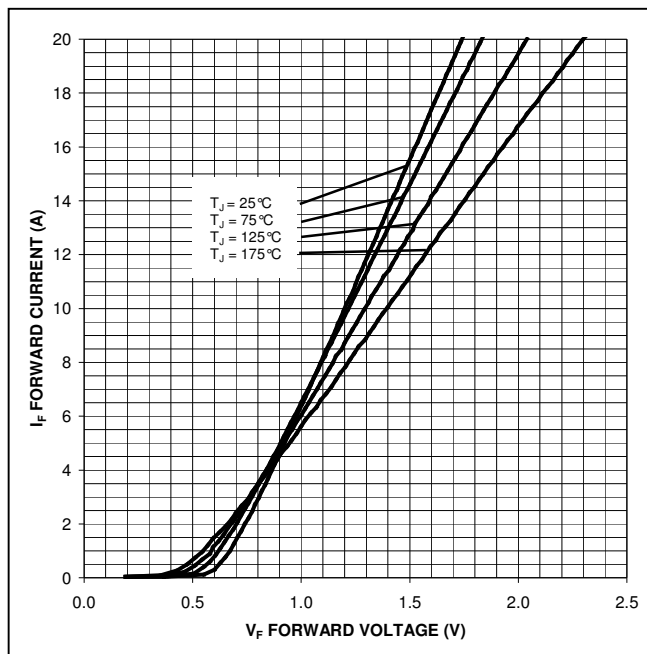

Figure 2. Reverse Characteristics

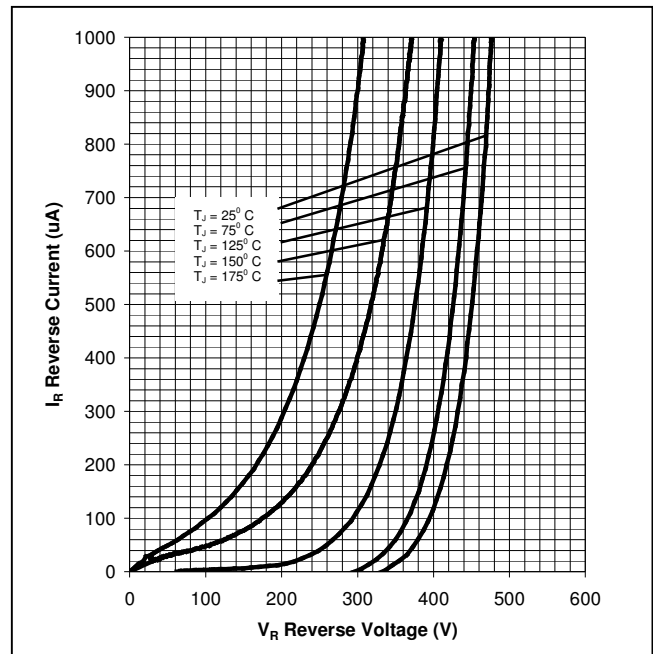

Figure 3. Current Derating

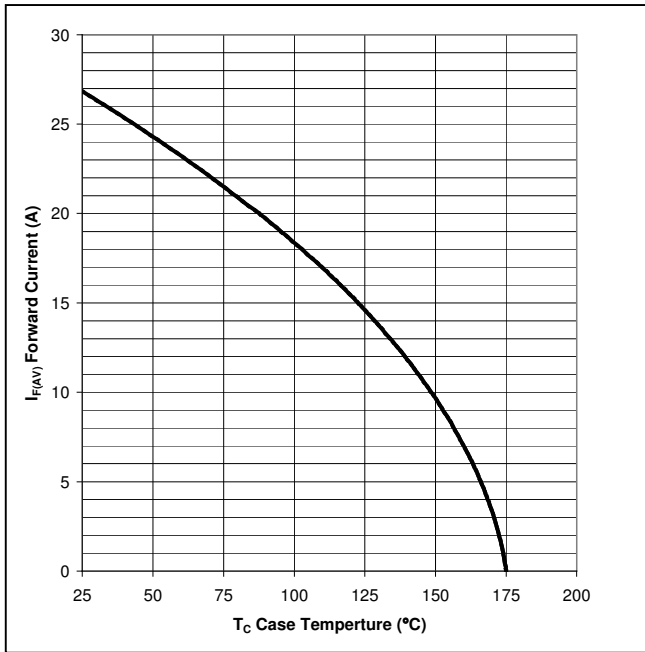

Figure 4. Capacitance vs. Reverse Voltage

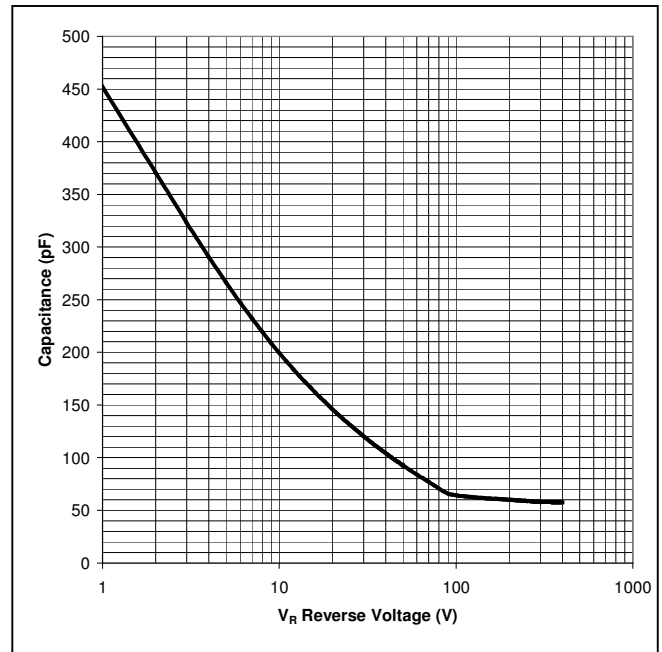
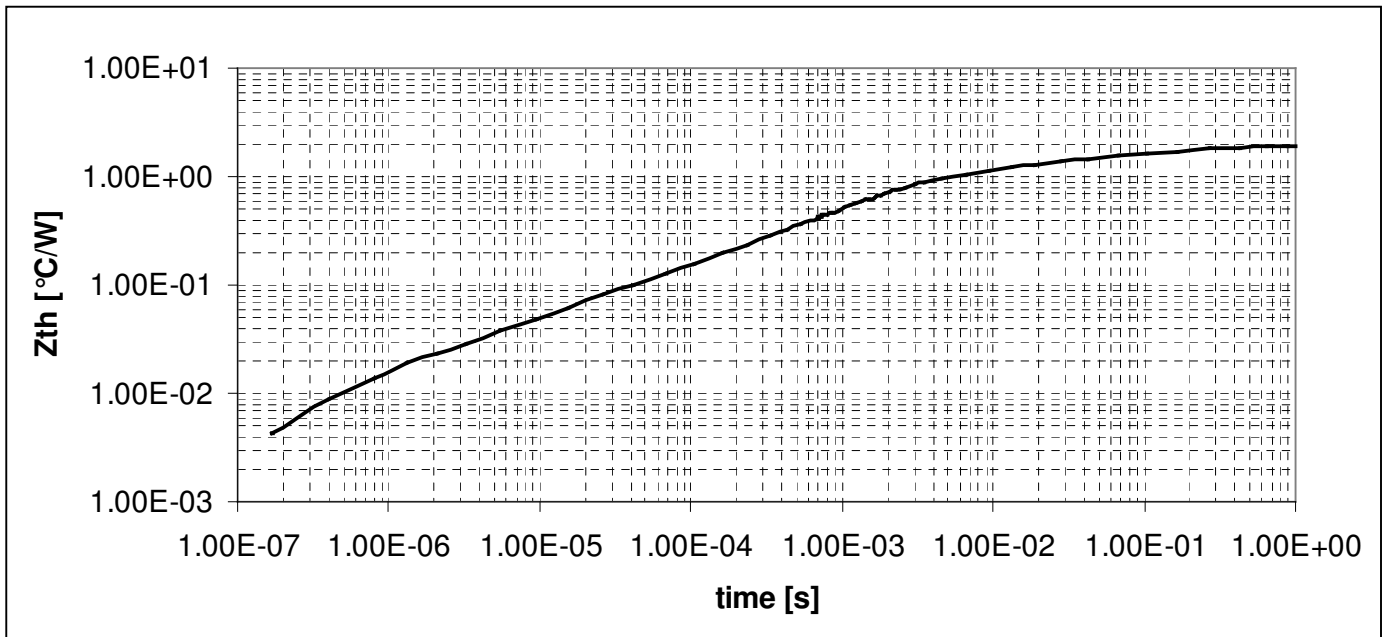
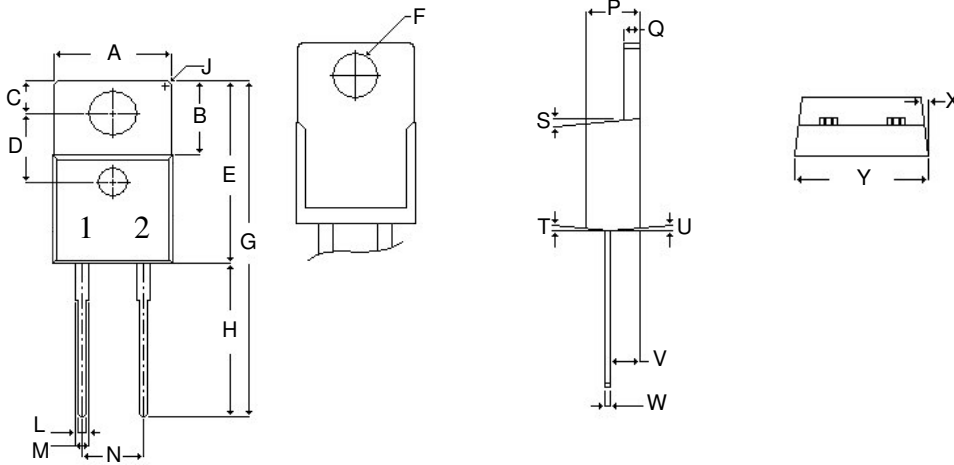

Figure 5. Transient Thermal Impedance



Package Dimensions

Package TO-220-2



POS	Inches		Millimeters	
	Min	Max	Min	Max
A	.381	.391	9.677	9.931
B	.240	.250	6.096	6.350
C	.100	.120	2.540	3.048
D	.223	.227	5.664	5.766
E	.595	.615	15.113	15.621
F	.143	.147	3.632	3.734
G	1.105	1.115	28.067	28.321
H	.500	.510	12.700	12.954
J	R 0.197		R 5.004	
L	.025	.035	.635	.889
M	.045	.055	1.143	1.397
N	.198	.202	5.029	5.131
P	.165	.185	4.191	4.699
Q	.048	.052	1.219	1.321
S	4°	6°	4°	6°
T	4°	6°	4°	6°
U	4°	6°	4°	6°
V	.094	.098	2.387	2.489
W	.018	.025	.458	.635
X	4.5°	5.5°	4.5°	5.5°
Y	.385	.405	9.779	10.287



Part Number	Package	Marking
CSD10030A	TO-220-2	CSD10030

Recommended solder pad layout.

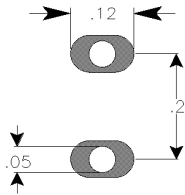

TO-220-2

This product has not been designed or tested for use in, and is not intended for use in, applications implanted into the human body nor in applications in which failure of the product could lead to death, personal injury or property damage, including but not limited to equipment used in the operation of nuclear facilities, life-support machines, cardiac defibrillators or similar emergency medical equipment, aircraft navigation or communication or control systems, air traffic control systems, or weapons systems.

Copyright © 2001-2004 Cree, Inc. All rights reserved. Permission is given to reproduce this document provided the entire document (including this copyright notice) is duplicated.

The information in this document is subject to change without notice.

Cree and the Cree logo are trademarks of Cree, Inc.

Cree, Inc.
Power Products
4600 Silicon Drive • Durham, NC 27703 • USA
Tel: 919-313-5300 • Fax: 919-313-5451
www.cree.com

This datasheet has been downloaded from:

www.DatasheetCatalog.com

Datasheets for electronic components.