

Piezo Keypad



12 key piezo keypad



16 key piezo keypad



Description

- Piezo keyboard available in version Standard, with Point Illumination, Lettering, varnished in different colours
- Mounting into the housing from the front or the rear
- Pins

Characteristics

- Housing material type: Plastics / front aluminium, version with stainless steel front on request
- With sealing kit as accessory for protection class IP68
- High reliability, long lifetime with more than 20 mill. actuations
- Easy to clean due to a tightly closed surface (IP 69K)
- Optional point illumination
- vandal proof protection (IK 05 impact resistance rating)

Weblinks

[html-datasheet](#), [General Product Information](#), [CE declaration of conformity](#), [RoHS](#), [CHINA-RoHS](#), [CAD-Drawings](#), [Product News](#), [Detailed request for product](#)

Technical Data

Electrical Data

Switching Voltage	max. 50 VDC
Switching Current	max. 200 mA
Contact Resistance ON	< 7.5 Ω
Contact Resistance OFF	> 5 MΩ
Dielectric Strength	2500V
Duration of Bounce	< 1 ms
Rated Breaking Capacity	600 mW

Mechanical Data

Actuating Force	1 - 3 N
Lifetime	> 20 million actuations
Shock Protection	IK 05 Aluminum, IK 04 Stainless Steel

Climatical Data

Operating Temperature	-25 to +85 °C
Storage Temperature	-40 to +85 °C
IP-Protection	IP 69K

Material

Front Panel	Alu. anodised / Stainless Steel
Assembling Plate	Ultradur
Insulating Disc	FR4
PCB	FR4
Piezo Disc	PZT

Detailed information on product approvals, code requirements, usage instructions and detailed test conditions can be looked up in [General Product Information](#)

Dimension

12 key piezo keypad

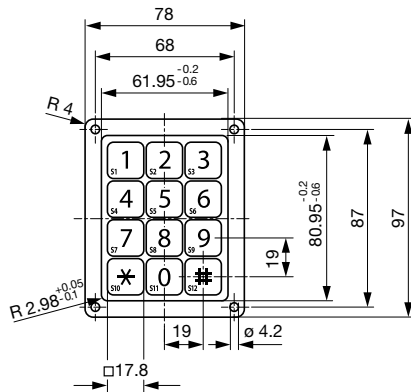

12 key piezo keypad

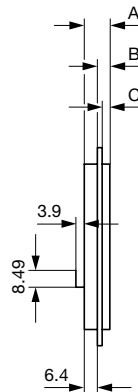

Partnumber	Material	Measures [mm]		
		A	B	C
1068.1012.1110001	Alu	11,33	4,93	3,13
1068.1012.2110001*	Stainless steel	11,23	4,83	3,03

*) The version with stainless steel frontplate is available on request.

12 key piezo keypad

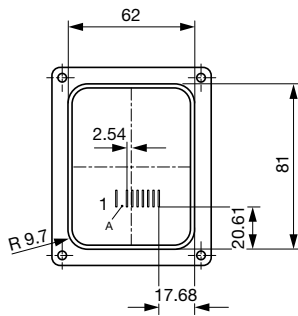

A = Pin 2 is removed and not contacted

16 key piezo keypad

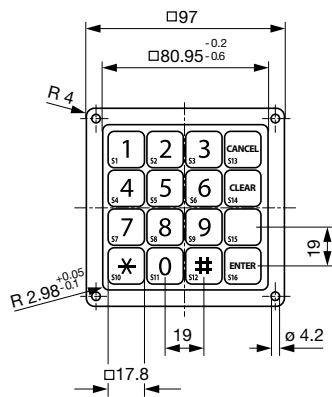

16 key piezo keypad

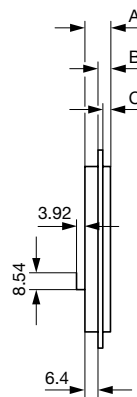

Partnumber	Material	Measures [mm]		
		A	B	C
1068.1016.1110001	Alu	11,33	4,93	3,13
1068.1016.2110001*	Stainless steel	11,23	4,83	3,03

*) The version with stainless steel frontplate is available on request.

16 key piezo keypad

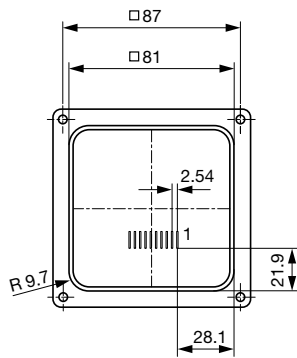

16 key piezo keypad with LED

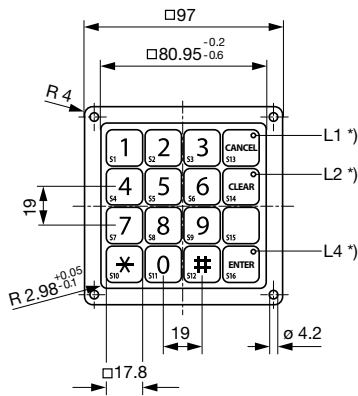

16 key piezo keypad with LED

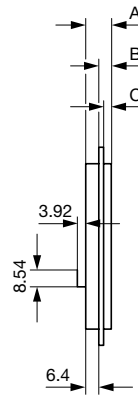

Partnumber	Material	Measures [mm]		
		A	B	C
1068.1013	Alu	11,33	4,93	3,13

*) The point illumination is customized available on request.

16 key piezo keypad with LED

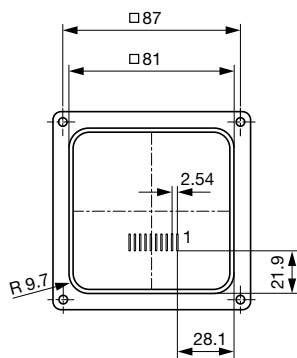

Diagrams

12 key piezo keypad

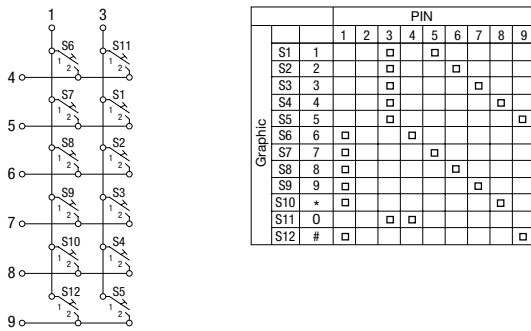

16 key piezo keypad

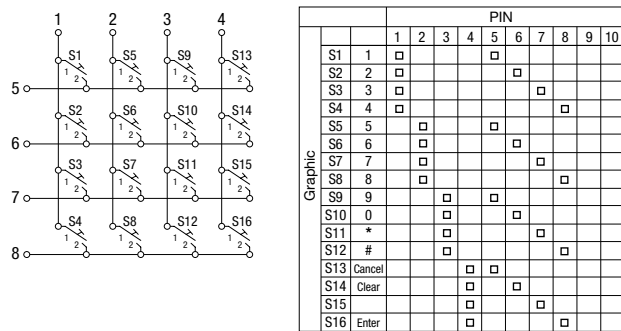

16 key piezo keypad with LED

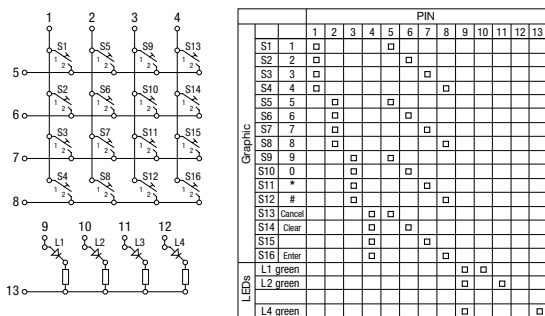

Pin 9 LED Supply common GND + 5 VDC

All Variants

Version	Keypads	Order Number
12 key piezo keypad	front aluminum, multi pin connector, standard lettering	1068.1012.1110001
12 key piezo keypad	front stainless steel, multi pin connector, standard lettering	1068.1012.2110001
16 key piezo keypad	front aluminum, multi pin connector, standard lettering	1068.1016.1110001

Customer-specific versions of lettering on request.

Availability for all products can be searched real-time: <http://www.schurter.com/en/Stock-Check/Stock-Check-SCHURTER>

Packaging unit 6 Reusable Packaging keypad with protective foil

Accessories

Description



Sealing Kit for Key Pad
Accessory Kit