

Cable gland - G-INSEC-PG48-L68N-NNES-S - 1411204

Please be informed that the data shown in this PDF Document is generated from our Online Catalog. Please find the complete data in the user's documentation. Our General Terms of Use for Downloads are valid (<http://phoenixcontact.com/download>)



Cable gland, Cable gland material: Brass, nickel-plated, External cable diameter 34 mm ... 44 mm, Shielding: yes, Connecting thread: Pg48, Color: silver



Key Commercial Data

Packing unit	1 pc
Custom tariff number	74199990
Country of origin	Turkey

Technical data

Dimensions

Length	65 mm
Wrench size, union nut	64 mm
Wrench size, support	64 mm
Hexagon angular dimension GRP	70 mm
Length of the connecting thread	14 mm
Feed-through hole diameter	59.4 mm ... 59.7 mm
External cable diameter	34 mm ... 44 mm

Ambient conditions

Degree of protection	IP68
Ambient temperature (operation)	-20 °C ... 100 °C (static)

General

No. of conductors	1
Cable gland material	Brass, nickel-plated
Seal material	Neoprene

Cable gland - G-INSEC-PG48-L68N-NNES-S - 1411204

Technical data

General

Cable seal material	Neoprene
O-ring material	NBR
Shielded	yes
Thread type on connection side	Pg48
Torque	35 Nm (Union nut)
Color	silver

Standards and Regulations

Connection in acc. with standard	UL
----------------------------------	----

Classifications

eCl@ss

eCl@ss 5.1	27149109
eCl@ss 6.0	27149109
eCl@ss 8.0	27149109

ETIM

ETIM 4.0	EC000441
ETIM 5.0	EC000441

Approvals

Approvals

Approvals

UL Recognized

Ex Approvals

Approvals submitted

Approval details

Cable gland - G-INSEC-PG48-L68N-NNES-S - 1411204

Approvals

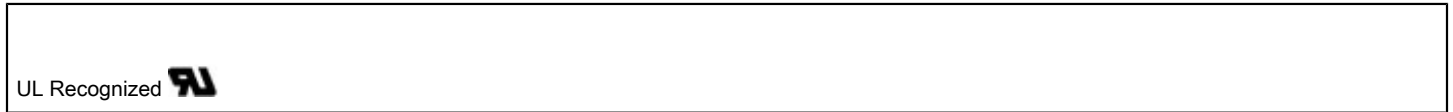

Drawings

Dimensional drawing

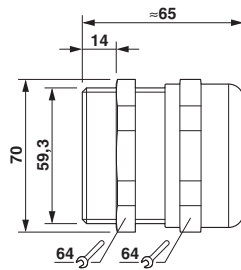

Dimensional drawing

Functional drawing

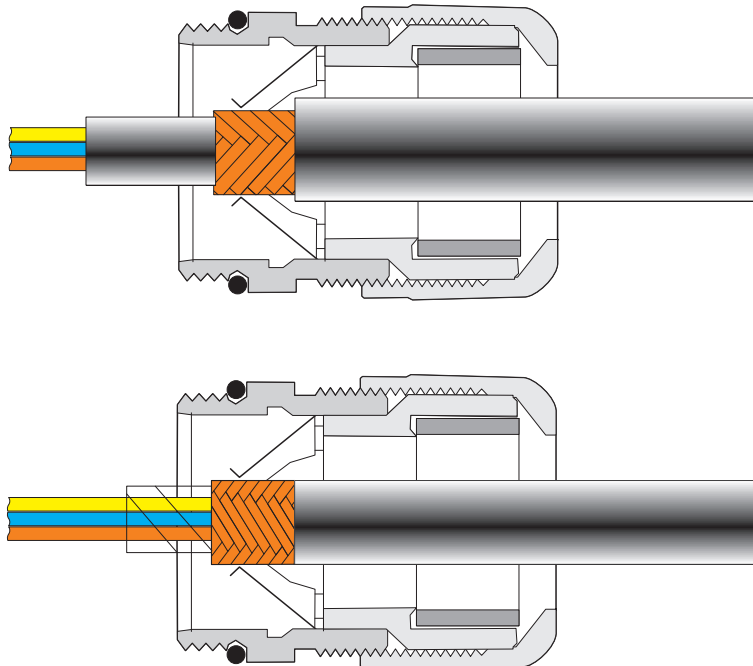

Assembly instructions:
Method 1

Cable gland - G-INSEC-PG48-L68N-NNES-S - 1411204

Slit the outer sheath after approximately 15 mm, but do not remove it. Guide the cable through the screw connection and then remove the outer sheath. Now withdraw the cable until a connection is established between the conductor shield and the contact spring.

Method 2

Push the braided shield back approximately 15 - 20 mm over the outer sheath. Insert the cable into the screw connection until a connection is established between the conductor shield and the contact spring.

Method 3

Uncover about 10 mm of the braided shield and guide the cable through the screw connection until a connection is established between the conductor shield and the contact spring.