

**Description**

- Standard 7 x 5mm crystal oscillator  
Ceramic package with a seam sealed metal lid, hermetically sealed
- Model CFPS-73
- Model Issue number 12

**Frequency Parameters**

- Frequency 24.0MHz
- Frequency Stability ±50.00ppm
- Operating Temperature Range -40.00 to 85.00°C
- Ageing ±3ppm per year max

**Electrical Parameters**

- Supply Voltage 3.3V ±10%
- Current Draw 12.00mA

**Output Details**

- Output Compatibility HCMOS
- Drive Capability 50pF max
- Rise and Fall Time 10.0ns max
- Duty Cycle 45/55

**Output Control**

- Logic '1' (>70% VS) to pad 1 enables oscillator output  
Logic '0' (<30% VS) to pad 1 disables oscillator output; the oscillator output goes to the high impedance state  
No connection to pad 1 enables oscillator output  
Standby Current: 10µA max

**Noise Parameters**

- Phase Noise @125MHz (typical):  
10Hz -54dBc  
100Hz -92dBc  
1kHz -130dBc  
10kHz -149dBc  
100kHz -159dBc  
1MHz -163dBc
- RMS Phase Jitter @125MHz: 52fs typical

**Environmental Parameters**

- Shock: MIL-STD-202, Method 213, Condition E
- Vibration: MIL-STD-883, Method 2007, Condition A
- Storage Temperature Range: -55 to 125°C

**Compliance**

- RoHS Status (2011/65/EU) Compliant
- REACH Status Compliant
- MSL Rating (JDEC-STD-033): Not Applicable

**Packaging Details**

- Pack Style: Reel Tape & reel in accordance with EIA-481-D  
Pack Size: 1,000
- *Alternative packing option available*

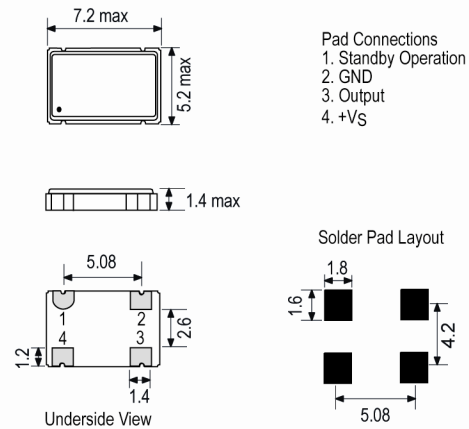
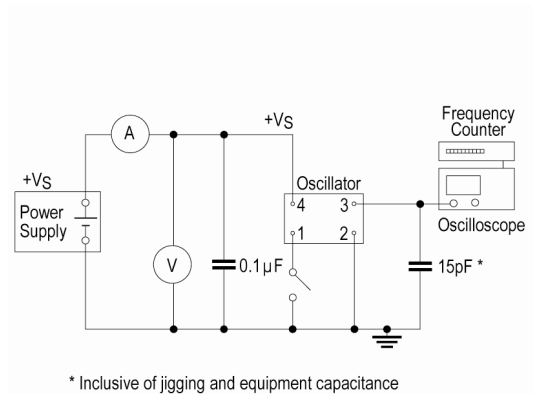
**Outline (mm)**

**Test Circuit**

**Sales Office Contact Details:**

 UK: +44 (0)1460 270200  
 Germany: 0800 1808 443

 France: 0800 901 383  
 USA: +1.760.318.2824

 Email: [info@iqdfrequencyproducts.com](mailto:info@iqdfrequencyproducts.com)  
 Web: [www.iqdfrequencyproducts.com](http://www.iqdfrequencyproducts.com)

**Wave Form**



**Phase Noise / Jitter**



**Sales Office Contact Details:**

UK: +44 (0)1460 270200  
 Germany: 0800 1808 443

France: 0800 901 383  
 USA: +1.760.318.2824

Email: [info@iqdfrequencyproducts.com](mailto:info@iqdfrequencyproducts.com)  
 Web: [www.iqdfrequencyproducts.com](http://www.iqdfrequencyproducts.com)